

FloorCare

PRODUCT RANGE
CATALOGUE



The development of floors and flooring materials within the broad range of commercial developments has been very pronounced over the past decade.

Not only have floors become more exotic in both design and material selection but, equally, we all expect to see the floor maintained to an exceptionally high standard, literally sparkling cleaning, in high profile locations; super clean in the workplace and public space... just as we would expect in our own living space.

Contents

Hurricane	4-7	TwinTec Vario	20-21
NuSpeed	8-9	TwinTec Ride-on	22-27
TwinTec Mains / Cable	10-13	Brushes and Pads	28-29
TwinTec Battery	14-19	Accessories	30-31



Buff it
Scrub it
 Strip it
 Ride on it
 Shampoo it
 Polish it
 Walk Behind it
 You
Name it!
 Concrete
 Stone
 Tile
 Carpet
 Single Disc
 Thermoplastic

The Right Equipment For The Right Job Will Provide The Right Results.

Hurricane *The 1000W Size*

The single disc floor machine is the heart of all hard floor cleaning and maintenance.

The Hurricane motor concept is designed to keep its "Cool" under continuous and arduous operation whilst its seamless power transmission to the floor is via our longlife, oil filled, low load planetary gearbox. THE HFM1015 150rpm machine is equipped with the 1000W Hurricane motor providing a lighter weight and economical solution.

- **Planetary Gearbox**
Longlife, oil filled, low load planetary gearbox.
- **Hi-Cool Motor**
Heavy duty, long life motor.
- **ATC (Automatic Torque Control)**
Monitoring and balancing power input throughout the cleaning cycle.
- **Fully Adjustable Handle**
For the perfect working position.

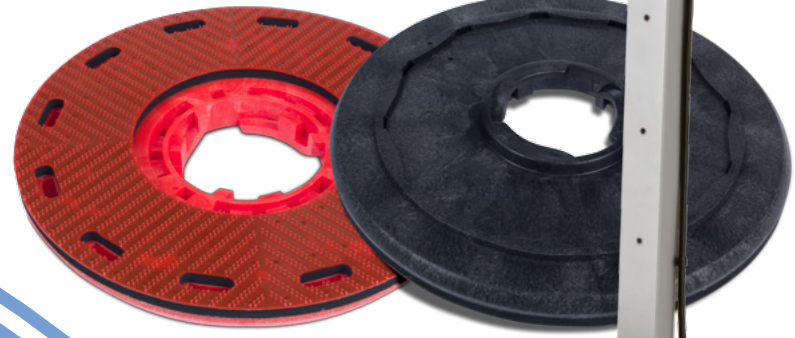

NuLoc2 Pad Drive System option



Large solution tank option

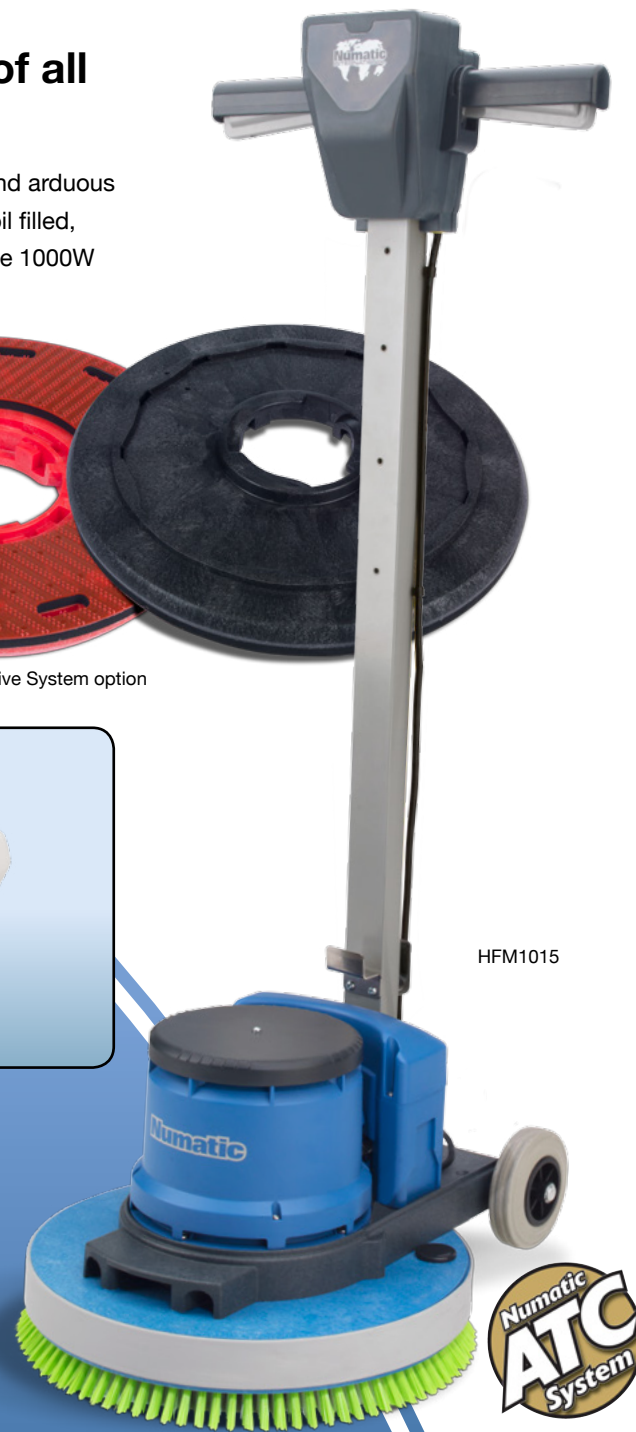

HFM1015



All Hurricane models incorporate our ATC, Automatic Torque Control, monitoring and balancing operational power input throughout the cleaning cycle.



Optional Hi-Dust Motor Filter

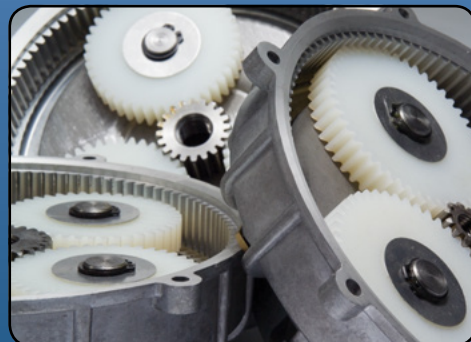

Planetary gearbox



Simple operator control

Model	Motor	Deck	Brush	Pad	Power	Speed	Range	Weight	Dimensions (WxLxH)
HFM1015	1000W	450mm	450mm	400mm	230V AC 50Hz	150rpm	32m	26kg	460x560x1250mm

Hurricane *The 1500W Size*

The HFM1500 series is available in a choice of 4 different speeds, 150rpm, 230rpm, 300rpm and extra Hi-speed 450rpm.

All models are fitted as standard with our generous oversize Hurricane 1500W drive motor allowing for higher speeds and the use of added weight as required.

The longlife, low load, oil filled planetary gearbox ensures seamless power transmission to the floor ensuring excellent results.

With the range of speeds available machines can be selected to cover the whole range of floor care maintenance be it scrubbing, polishing, buffing, burnishing or spray cleaning.

- **Planetary Gearbox**
Longlife, oil filled, low load planetary gearbox.
- **NuLoc2 Systems**
Optional pad interchange systems, quick, simple and secure.
- **Hi-Cool Motor**
1500W motor allowing for higher speeds and the use of added weight as required. Available in a choice of 4 speeds 150rpm, 230rpm, 300rpm, 450rpm.
- **ATC (Automatic Torque Control)**
Monitoring and balancing power input throughout the cleaning cycle.
- **Fully Adjustable Handle**
Adjustable for the perfect position.

- **Accessories**
A range of accessories available to cover wet applications, carpet shampooing, vacuum polishing and floor sanding.



HFM1515



Optional spray clean system

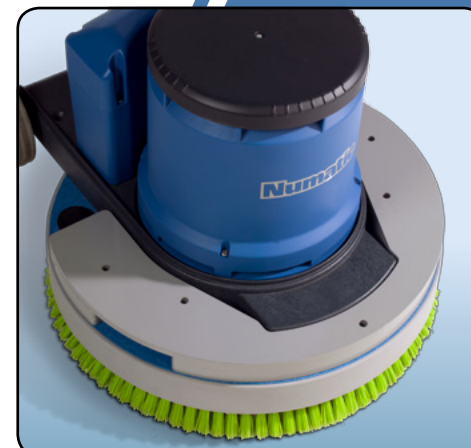

Optional 10kg additional weight

Model	Motor	Deck	Brush	Pad	Power	Speed	Vacuum	Range	Weight	Dimensions (WxLxH)
HFM1515	1500W	450mm	450mm	400mm	230V AC 50Hz	150rpm	Optional	32m	32kg	460x560x1250mm
HFM1523						230rpm				
HFM1530						300rpm				
HFM1545						450rpm				

Hurricane *The Two Speed*

There are more and more applications where the floor machine must fulfil two functions literally at the "Flick of a Switch".

The HFT model is fitted with the Hurricane dual performance motor rated at 1000W / 1250W providing optimised power options at the two different operating speeds. For scrubbing you want 150rpm but for polishing 300rpm giving quicker and better results. This is very much the case in hospitals, care homes, hotels, schools, etc. where the needs vary quite substantially each day and two separate machines are not always practical or available.

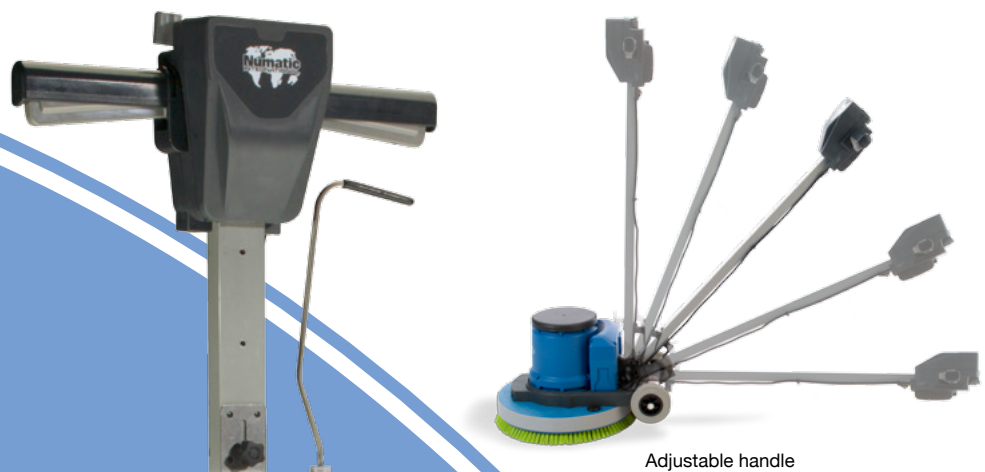

Adjustable handle

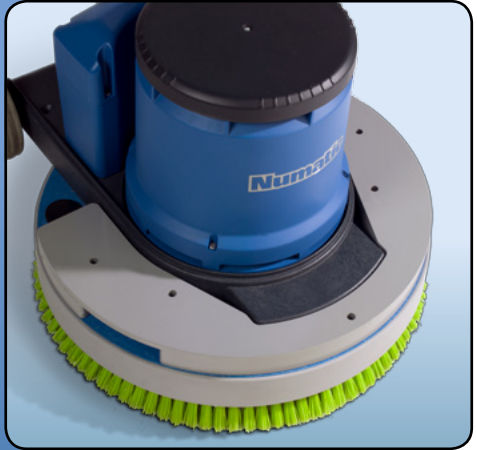

Optional 10kg Additional weight (150rpm)

HFT1530



HFT Twin speed selection

- **Planetary Gearbox**
Longlife, oil filled, low load planetary gearbox.
- **Dual Speed**
Dual speed motor giving speeds of 150rpm for scrubbing and 300rpm for polishing.
- **ATC (Automatic Torque Control)**
Monitoring and balancing power input throughout the cleaning cycle.
- **Accessories**
A range of accessories available to cover wet applications, carpet shampooing, vacuum polishing and floor sanding.

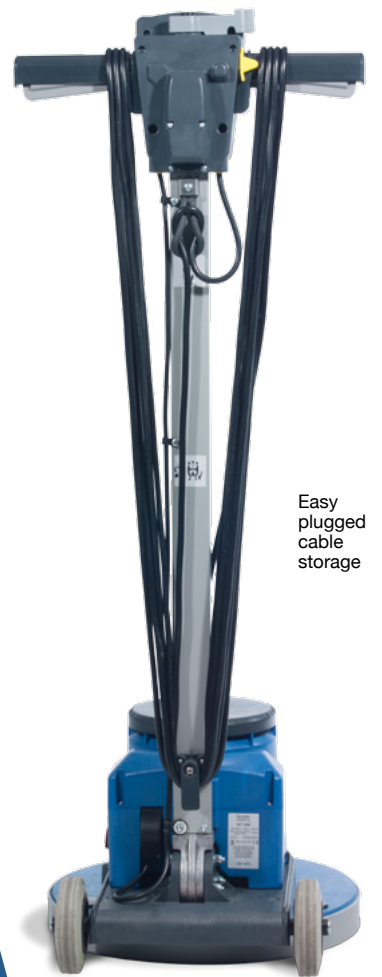

Easy plugged cable storage

Hurricane NuShine *The High Speed Burnisher*

Great styling, easy control and powerful. Designed to allow for effortless performance at higher burnishing speeds. When size and weight are a factor the HNS offers the ideal balance.

A compact yet powerful machine with supreme manoeuvrability. If you want stunning results combined with effortless performance then this is the machine for you. The NuShine has complete directional control which means a consistently high standard of finish.



LCD power / overload indicator

- **Powerful Hi-Cool 1500W Motor**
Heavy duty, longlife motor.
- **Automatic Torque Control**
Monitoring power and balance.
- **Fully Adjustable Operator Handle**
Easy to use and fully adjustable operator handle.
- **Effortless**
All direction control with superb manoeuvrability.
- **Brush Pressure Monitor**
Allowing you to be in control of the surface finish achieving optimum results with superior handling.

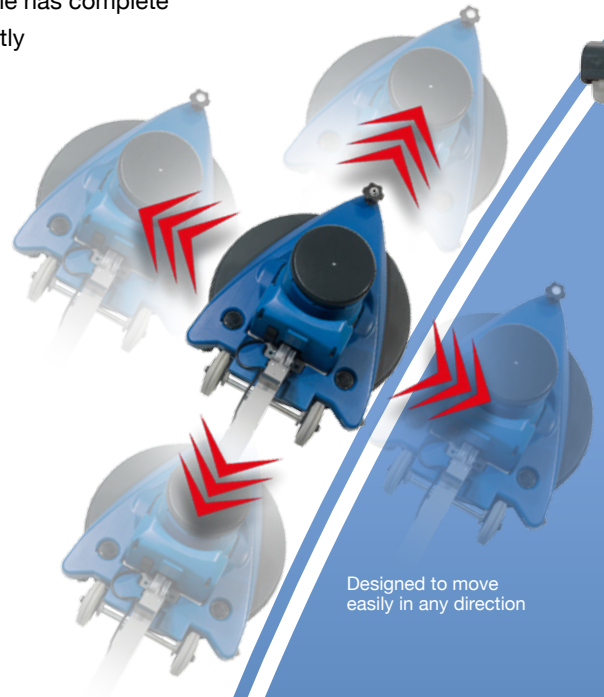

Designed to move easily in any direction

HNS1550



Simple load adjustment



Hurricane Hi-Cool heavy duty motor technology



Model	Motor	Deck	Brush	Pad	Power	Speed	Vacuum	Range	Weight	Dimensions (WxLxH)
HFT1530	1000 / 1250W	450mm	450mm	400mm	230V AC 50Hz	150 / 300rpm	Optional	32m	32kg	460x560x1250mm

Model	Pad	Motor Power	Speed	Pad Pressure	Cleaning Range	Weight	Dimensions (WxLxH)
HNS1550	500mm	1500W	1500rpm	Variable	32m	25kg	560x740x1260mm

NuSpeed *The Super Compact Size*

The LoLine will put truly usable power, convenience and efficiency in the hands of the operator, giving superb results.

The LoLine rotary has been designed specifically to meet the demand and raise the handling and performance levels to an exceptional user friendly standard.

Our LoLine NLL332 can claim performance characteristics equal to that of bigger, more industrial machines, yet with an ease and speed of operation that will immediately endear it to any user.

A full range of 33cm (13") brushes and pad drives allows the machine to be used for all of the primary floor care functions.



Solution tank option



Flat folding for easy storage

- **Pads and Brushes**

Full range of 33cm (13") brushes and pad drives for all primary floor care functions.

- **Easy Storage**

Only 18kg in weight, compact size and folding design means easy and convenient to move and store.

- **200rpm**

200rpm means versatility but equals performance of bigger more industrial machines.

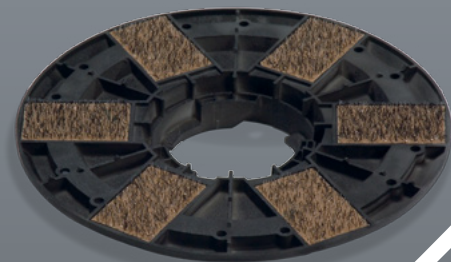

Model	Motor	Deck	Brush	Pad	Power	Speed	Vacuum	Range	Weight	Dimensions (WxLxH)
NLL332	400W	330mm	330mm	330mm	230V AC 50/60Hz	200rpm	-	32m	18kg	450x580x1185mm

8 Images may include optional accessories for illustration purposes.

NuSpeed *The Full Size*

The NuSpeed range of professional FloorCare machines has been specifically designed to provide optimum results whatever the application.

All NuSpeed NR models within the range are equipped with our performance enhancing ATC (Automatic Torque Control) feature. This is a unique system that monitors operation and boosts torque as required to provide consistent performance under varying load conditions.

- **ATC**

ATC (automatic torque control) monitoring and balancing power input throughout the cleaning cycle.

- **Xtra Weight**

Unique NuSpeed design means an increase in operating weight of 40kg can be achieved within the standard specification.

- **Easy Storage**

Compact size and folding handle means easy and convenient to move and store.

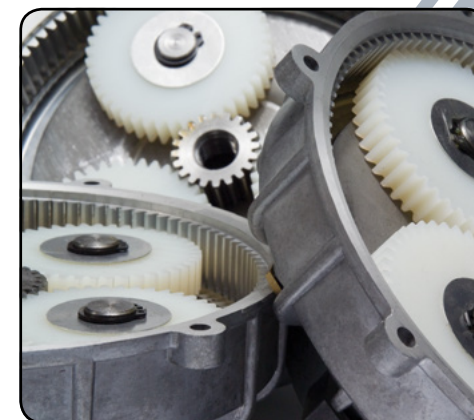

Planetary gearbox

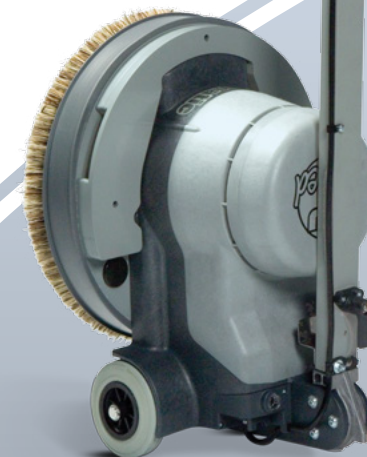

NR1500 folded for storage



NR1500



(See page 30 for full accessories)

Model	Motor	Deck	Brush	Pad	Power	Speed	Vacuum	Range	Weight	Dimensions (WxLxH)
NR1500S	1500W	400mm	450mm	400mm	230V AC 50/60Hz	150rpm	Optional	32m	40kg	460x580x1250mm

TwinTec *The Cylinder Machine*

Designed to be compact, easy to operate and exceptionally manoeuvrable when in use, whilst the oversized transit wheels allow easy movement to and from any specific locations.

The cylinder power brush ensures deep cleaning performance, whilst the twin water pick-up nozzles allow multi-directional operation which is vitally important when cleaning narrow walkways often found in shops and food stores. You can walk in forwards and reverse out without turning and without loss of scrubbing and drying performance.

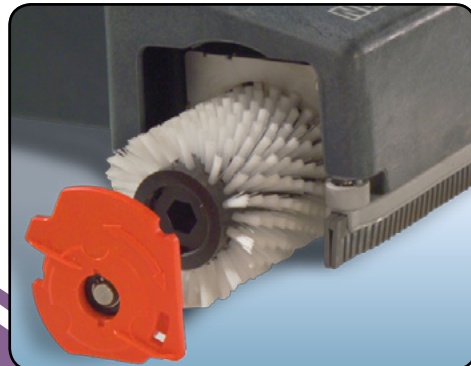

Simple brush access



Overfill cut-off system

- **Compact**
Yet exceptionally manoeuvrable.
- **Multi-directional**
Twin water pick-up nozzles for all round cleaning.
- **Cylinder Power Brush**
Ensures deep cleaning.
- **Swing Steering**
Provides easy directional control.
- **Transit Wheels**
Oversized transit wheels allow easy movement to and from any location.
- **Simple Control**
Easy to use operator controls.



Adjustable water flow



Operator controls



TT1535G

Please note: Available January 2017

Model	Brush Motor	Vac Motor	Power	Brush Speed	Range	Brush Width	Capacity	Weight	Dimensions (WxLxH)
TT1535G	400W	1000W	220-240V 50Hz	1000rpm	42m	350mm	15L	38kg	480x750x740mm

10 (See pages 30-31 for full accessories)

TwinTec *The Compact Single Disc*

The TwinTec 1840 cable machine has been designed to address the question of size being exceptionally compact, yet with performance equal to bigger machines.

The compact design really does allow this machine to clean in areas normally cleaned by hand, yet 30% to 40% faster and better.

Although designed for small and congested areas the TT1840G is equally at home in larger areas and can be used in conjunction with our cable reel, "the cable reel that rolls", extending the cable length from 20m to 40m without any loss of performance.

The style and proportion of the polyform water tanks allow for the machine to adopt a convenient tilt position with only approximately 5 litres in the clean water tank to facilitate single handed brush or pad changing.

20m Cable reel (optional)



TT1840G

- **Water Feed System**
360° liquid feed for uniform delivery.
- **Convenient**
Fold flat design for easy transport from site to site.
- **Rugged Construction**
Tough all steel chassis design.
- **Fully Adjustable Handle**
For the perfect working position.
- **Low Noise**
Quieter, unobtrusive design means true versatility.
- **Easy Change**
Easy one handed brush or pad changing.



Visible operation



Simple controls



Easy and generous fill cap

Please note: Available January 2017

Model	Brush Motor	Vac Motor	Power	Brush Speed	Range	Pad / Brush Width	Capacity	Weight	Dimensions (WxLxH)
TT1840G	400W	300W	220-240V 50Hz	150rpm	42m	360 / 400mm	18L	40kg	520x880x1132mm

TwinTec *A Range of Two*

The TwinTec mains cable range has masterful performance moving under its own brush power with amazing speed and purpose. Available with 45 or 55cm scrub width.

When selecting a scrubber dryer machine, the area that needs to be cleaned and the time available to clean it will determine the preferred size of the brush system.

Care must be taken, however, to ensure that bigger is better but not too big, taking into account the obstructions that must be navigated during the daily cleaning cycle.

- **TwinFlo Vacuum Motor**
Provides exceptional wet pick-up.
- **Structofoam Tilting Brush Deck**
Making brush changes quick and simple.
- **Planetary Gearbox**
Longlife, oil filled, low load gearbox.
- **Simple Control**
Simple on / off trigger controls.
- **Polyform Tanks**
Heavy duty clean and dirty water tanks.
- **Flexifill System**
Easy filling and emptying system.
- **Structofoam Chassis**
Incredibly tough and chemical resistant Stuctofoam moulded chassis.

TT4055G



Tilting deck for easy brush change and storage



Additional fill and filter point



Fully adjustable handle



Simple controls

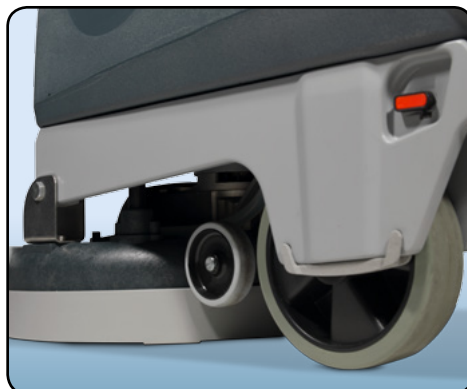

Full moulded chassis and non-marking wheels

Model	Brush Motor	Vac Motor	Power	Brush Speed	Range	Pad / Brush Width	Capacity	Weight	Dimensions (WxLxH)
TT4045G	1500W	1200W	220-240V 50Hz	150rpm	42m	400 / 450mm	40L	67kg	470x890x1100mm
TT4055G						500 / 550mm			

Please note: Available January 2017

TwinTec *Big & Bold*

The TT6650G cable machine is a genuine workhorse providing a truly cost effective answer to big area low cost floor maintenance.

First and foremost the user will find the TT6650G as easy to use as our smaller machines with the control and operation systems to exactly the same specification, it handles like a dream.

Big capacity polyform tanks provide a full 60 litre capacity to match the exceptionally stable 65cm single brush scrubbing head, complemented by an oversized, floating aluminium floor tool.

- **Polyform Tanks**
Heavy duty clean and dirty water tanks.
- **Structofoam Tilting Brush Deck**
Making brush changes quick and simple.
- **Fully Adjustable Handle**
For the perfect working position.
- **TwinFlo Vacuum Motor**
Provides exceptional wet pick-up.
- **Stainless Chassis**
Strong stainless steel chassis.

TT6650G



Stainless steel chassis



Easy tank filling access



Tilting deck for easy brush / pad change and storage

Model	Brush Motor	Vac Motor	Power	Brush Speed	Range	Pad / Brush Width	Capacity	Weight	Dimensions (WxLxH)
TT6650G	1500W	1200W	220-240V 50Hz	150rpm	42m	600 / 650mm	60L	87.6kg	970x1260x1230mm

Please note: Available January 2017

TwinTec Battery Compact

The TwinTec 1840 machine has been designed to address the question of size being exceptionally compact, yet with performance equal to bigger machines.

The compact design really does allow this machine to clean in areas normally cleaned by hand, yet 30% to 40% faster and better.

- **Battery Pack**
Quick change 24V gel battery pack.
- **Cable Free**
Total freedom of 24V battery operation.
- **Water Feed System**
360° water feed system for uniform liquid delivery to floor.
- **Fully Adjustable Handle**
Flat to upright for perfect position.
- **Parabolic Squeegee**
270° rotating parabolic squeegee system.
- **Quick Change**
Fast, single handed brush or pad changing.
- **Hi / Lo Mode**
For quieter cleaning when needed.



TTB1840G



Visible operation



Folds down for easy storage or transit

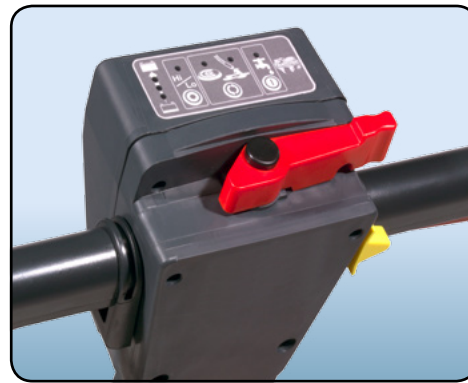

Simple soft touch controls



Quick change gel battery pack



Easy and generous fill cap

Please note: Available January 2017

Model	Brush Motor	Vac Motor	Power	Runtime	Recharge Time	Pad / Brush Width	Capacity	Weight	Brush Speed	Dimensions (WxLxH)
TTB1840G	400W	300W	2x12V (24V 18Ah)	45min	6hr	360 / 400mm	18L	52kg	150rpm	520x850x1132mm

14 (See pages 30-31 for full accessories)

TwinTec Battery GelTec Compact

NEW

Does 23 years of practice make a better scrubber dryer? Yes, the TTB345 is where it all started. It's been a leader for 23 years and today's new GelTec TGB3045 is a further advance and tomorrow's new classic.

The TGB3045 offers the best of both worlds with compact design and a full width cleaning capability.

- **Easy to use controls**
Now with red touch user friendly controls.
- **Gel Batteries**
Up to 2hr runtime, 10hr charge time.
- **Battery and Hour Meter**
Simple clear hour / battery indicator.
- **Fully Adjustable Handle**
Flat to upright for perfect position.
- **Structfoam Chassis**
Incredibly tough and chemical resistant polyform moulded chassis.
- **30L Capacity Polyform Tank**
Heavy duty clean and dirty water tanks.
- **45cm Scrub Width**
Tilting deck for easy brush change.



TGB3045



Structfoam chassis



Simple controls

Please note: Available January 2017

Model	Brush Motor	Vac Motor	Power	Working-time	Recharge Time	Pad / Brush Width	Capacity	Weight	Brush Speed	Dimensions (WxLxH)
TGB3045	300W	400W	2x12V (24V 55Ah)	upto 2hr	10hr	400 / 450mm	30L	90kg	100rpm	470x890x1100mm

15

TwinTec Battery *Setting the Standard*

With these machines every part is designed to combine the best in functionality and reliability.

The TGB4045 is the classic Numatic TwinTec 24V battery model. It started its life with 30 litre capacity, now raised to 40 litre, and is today the most popular model worldwide. The premium specification starts with a steel chassis, structofoam tilting brush deck, polyform tanks, fully sealed gel batteries, built in battery charger, heavy duty TwinFlo wet pick-up vacuum system and heavy duty geared brush drive.

The 4055 is one size up from the 4045 containing all the advanced TwinTec 24V features but with a 20% increased cleaning path.

The 4055T (traction) offers effortless cleaning due to the powerful traction unit. A traction model is essential where inclines such as wheelchair ramps are present.



Simple controls

- Fully Sealed Gel Batteries**
 Maintenance-free batteries to ensure the highest standard of operational life.
- Twinflo Vacuum Motor**
 Provides exceptional wet pick-up.
- Structofoam Tilting Brush Deck**
 Making brush and pad changing quick and easy.
- Easy Operation**
 Simple on / off trigger control.
- On-board Charging**
 Convenient and easy, just plug and go.



On-board charger

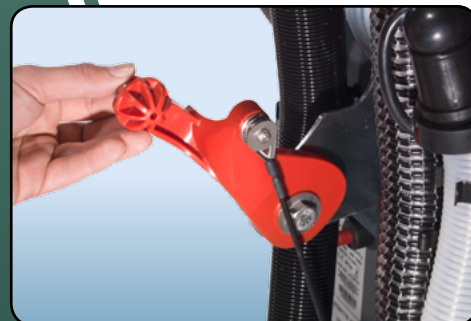

Floor tool lifting / lowering handle



Additional fill and filter point



TGB4045

TGB4055
TGB4055T

Please note: Available January 2017

Model	Brush Motor	Vac Motor	Power	Runtime	Recharge Time	Pad / Brush Width	Capacity	Weight	Traction Drive	Brush Speed	Dimensions (WxLxH)
TGB4045						400 / 450mm		128kg			470x1070 x1160mm
TGB4055	300W	400W	2x12V (24V 100Ah)	2.25hr	8hr	500 / 550mm	40L	134kg		100rpm	560x1115 x1160mm
TGB4055T				2.0hr		500 / 550mm		140kg	250W		

T= Traction drive

TwinTec Battery 50% More Capacity for bigger areas

Easy-to-use controls combined with professional cleaning.

The 55cm (20") size of TwinTec is becoming more and more popular and, in support of this, we have introduced two new models with 60 litre capacity, a 50% increase over the 40 litre models and available in both traction and non-traction specifications.

Both models of TGB6055 have 60 litre capacity and a 55cm (20") single brush scrubbing path, dual brush pressure selection, built in battery charging, easy fill and easy emptying facilities, with added traction power drive for the 6055T model which would be essential if inclines or ramps are involved.



Plug-in charger system



Easy battery access

Simple to use control panel TGB6055 shown

- Key Ignition Switch
- Hours meter
- Battery level indicator
- Vacuum On / Off
- Water flow On / Off



...50% More Capacity for bigger areas



Flexifill filling hose



TGB6055 Traction model control panel

- **Simple Operator Controls**
2 switches for vacuum and water.
- **On-board Charging**
Convenient and easy, just plug and go.
- **Gel Batteries**
Up to 2.25hr runtime, 8hr charge time.
- **Flexifill System**
Easy filling and emptying with flexifill system.
- **Battery and Hour Meter**
Simple clear hour / battery indicator.
- **Traction Drive System**
Makes the cleaning of inclines safer and easier (TGB6055T).



TGB6055

Please note: Available January 2017

Model	Brush Motor	Vac Motor	Power	Runtime	Recharge Time	Pad / Brush Width	Capacity	Weight	Drive Speed	Brush Speed	Dimensions WxLxH
TGB6055	300W	400W	2x12V (24V 100Ah)	2.25hr	8hr	500 / 550mm	60L	165kg	-	100rpm	560x1280 x1160mm
TGB6055T									4.2kph		

T= Traction drive

TwinTec Vario *Two Into One Goes Again, Even Bigger*

The TwinTec Vario 5565 represents, in every way, the optimum walk behind traction auto-scrubber with a range of advanced, yet practical, features that truly allow us to claim... "Best in Class".

This TwinTec gets its Vario name from the fact that this one machine can, by a no tools adjustment and simple brush change, be set to operate at either a 55cm or 65cm scrubbing width... two machine choices in one.



...Two Into One Goes Again, Even Bigger

- **Flexifill System**
Easy filling and emptying with the flexifill system.
- **Complete Cleaning Control**
Simple one touch dosing control and versatile variable speed control.
- **Adjustable Scrub Widths**
55cm or 65cm scrubbing width by virtue of the adjustable dual setting Vario deck design.
- **Spot Cleaning**
Heavy duty spot cleaning means operator can over-ride standard brush pressure to 50kg for extra performance.
- **Easy Transportation**
Built in easy transit mode for easy transportation between areas.
- **On-board Charging**
Convenient and easy, just plug and go. Fully sealed low maintenance gel batteries.
- **Simple Operator Control**
Nutronic soft touch operator controls.
- **Safety Features**
Built in emergency stop button and removable power off key are just two of the many safety features.



Easy battery access

Beneath the hinged dirty water tank sits the operating heart of the Vario with its 200Ah gel battery and charging system, high performance suction unit and NuChem dosing facility... all easily accessible.



TTV5565

In the 65cm mode the scrubbing head is automatically expanded to a practical offset operating mode, providing a 100mm head extension to the right hand side. This simple arrangement allows improved edge cleaning especially in aisles with racking or other obstructions.

The operator controls are a separate feature in their own right with independent selection of speed, water flow and chemical dosing all built in to the basic unit, all of which can be set to provide total convenience and consistency of operation.



Simple to use Nutronic control panel

The unique TwinTec 55cm / 65cm dual brush system...

A simple, no tool adjustment and brush change allows a selection of either 55cm or 65cm scrubbing widths.

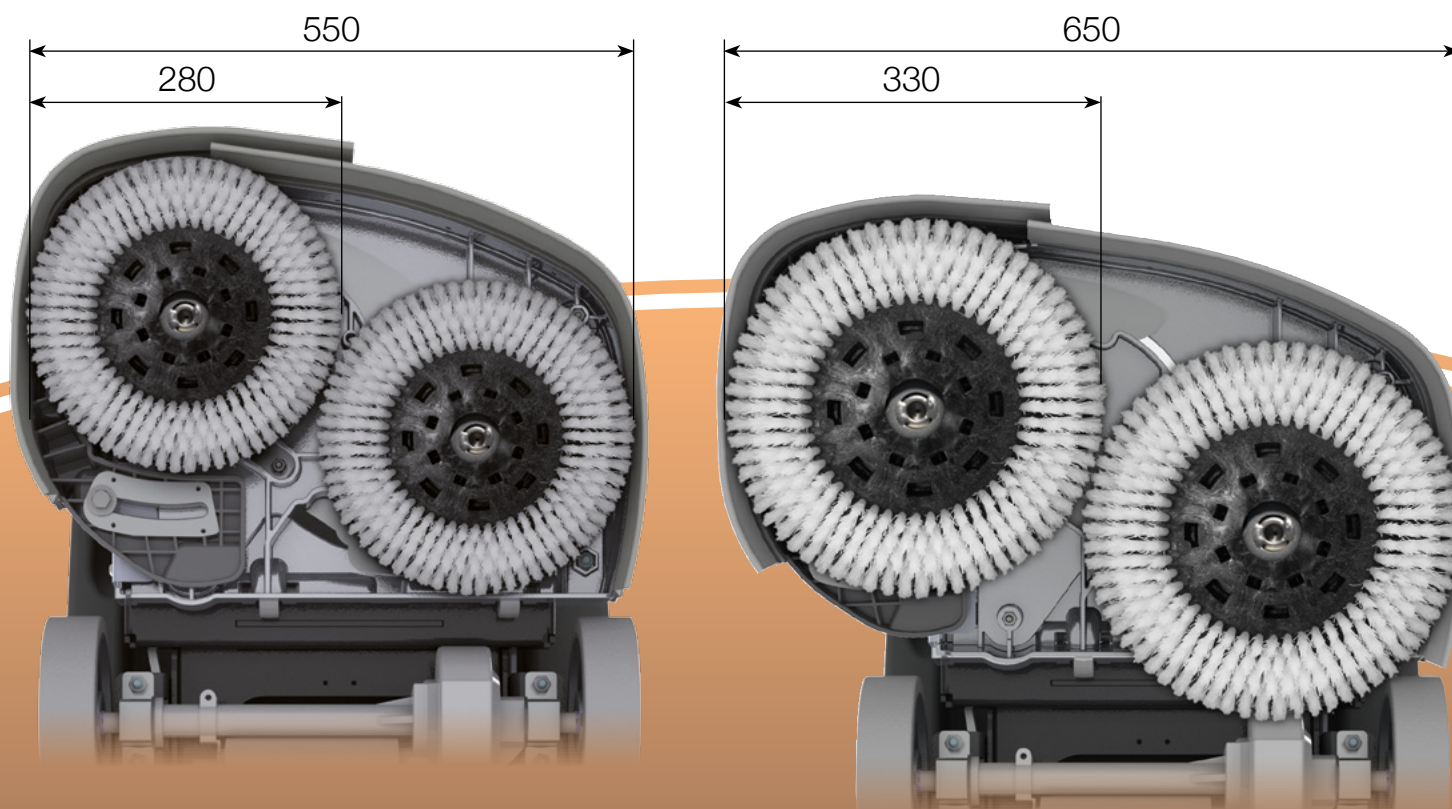

Model	Brush Motor	Vac Motor	Power	Runtime	Recharge Time	Traction Drive	Drive Speed	Cleaning Speed	Climbing Gradient	Scrub Widths
TTV5565	2x330W	600W	4 x 12V (24V) = 200Ah	3.5hr	10-12hr	250W	2.5km/h	2.5km/h	9%	550mm 650mm
Brush Speed	Water Capacity	NuChem Capacity	Water Flow Rate	NuChem Mix		Weight	Dimensions (WxLxH)			
200rpm	85L	Optional 5L	3, 2, 1, .5L/min	25:1, 50:1, 75:1, 100:1		287kg	585x1400x1135mm			

Compact Ride-on 8055

Not too big, not too small, good capacity, simple controls, excellent performance and very competitive in terms of price.

In truth the CRO8055G is competitive with most walk behinds of the same size. So now you can sit rather than walk and by virtue of the exceptional manoeuvrability, substantial time will be saved on middle size applications.

The CRO8055G also introduces the logic of two machines in place of something much bigger or, to put it another way, Two for the Price of One with added versatility and convenience.

The CRO will go into places where bigger machines are not suitable and anything smaller is just too small.

- **Compact Design**
Means easy cleaning in tight spaces.
- **Anti-tip System**
Prevents the machine from tipping when cornering on full lock.
- **On-board Charging**
Easy and convenient, just plug and go. Fully sealed low maintenance Gel batteries.
- **Flexifill System**
Easy filling and emptying with the flexifill system.
- **Easy Operator Control**
With fully adjustable speed control.

- **Safety Features**
Emergency stop button, removable power off key, horn button and built in hazard warning light are just a few of the safety features included.
- **Easy Maintenance**
Easy access to batteries and fuses for maintenance.

Compact Ride-on Twin Brush 8072

All the benefits of CRO compact design with added WideTrack cleaning.

The CRO8072G brings all the features of the popular 8055 model with an additional 30% scrub width. The 2 x 370mm brush configuration provides an astonishing 720mm cleaning width on a ultra compact Ride-on. More cleaning... same user convenience.



Easy battery and filter access



CRO8055G



CRO8072G



Flexifill hose

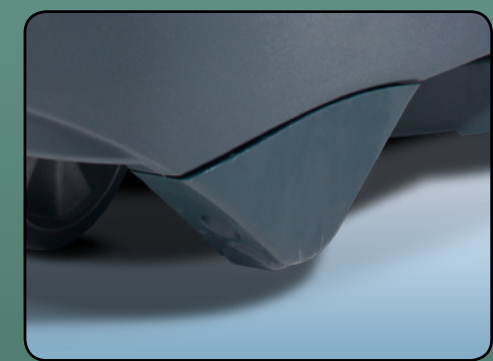

Anti-tip side buffers



Heavy duty integral chassis (CRO8055G shown)

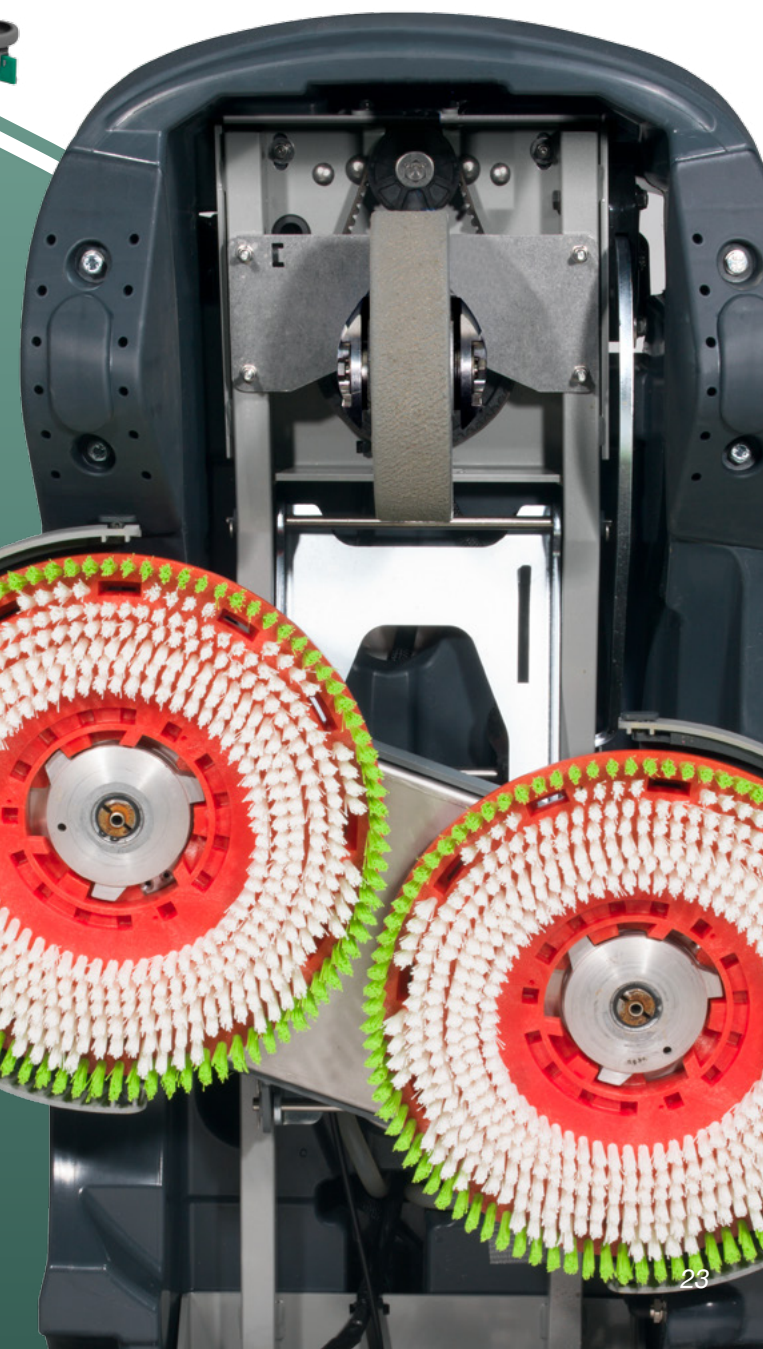

CRO8072G twin brush design



Charger port

Model	Brush Diameter	Capacity	Battery Power	Runtime	Recharge Time	Traction Drive	Clean Speed	Vacuum Motor	Brush Speed	Brush Motor	Dimensions (WxLxH)
CRO8055G / 100 CRO8055G / 200	550mm	80L	2 x 12V (24V) = 100 Ah 2 x 12V (24V) = 120 Ah	2hr 3hr	2 x 100 Ah = 10A - 8hr 2 x 120 Ah = 20A - 7hr	400W	6km/h max	400W	150rpm	1 x 600W	805x1460x1160mm
CRO8072G	2 x 370mm	80L	2 x 12V (24V) = 120 Ah 2 x 12V (24V) = 100 Ah	2hr 3hr	2 x 100 Ah = 10A - 8hr 2 x 120 Ah = 20A - 7hr	400W	6km/h max	400W	150rpm	1 x 600W	805x1460x1160mm

TwinTec Ride-on *A Serious Workhorse*

A more user friendly ride-on scrubber dryer would be hard to find. Designed to provide long, simple and reliable service day in day out whatever the environment.

The TRO650G is based on the well established engineering of the Vario TTV678 model but simplified to provide a truly professional, cost effective workhorse. You can vary the water flow and the operating speed to suit a whole host of conditions from big areas lightly soiled to heavy duty scrubbing in more arduous conditions.



TRO650G



Easy brush access

The TRO650G is blessed with a commanding operator driving position, front wheel traction drive, a magnificent turning circle and one pass performance that really will ensure you get the standard you want, exactly when you want it... and fast.



Easy maintenance access

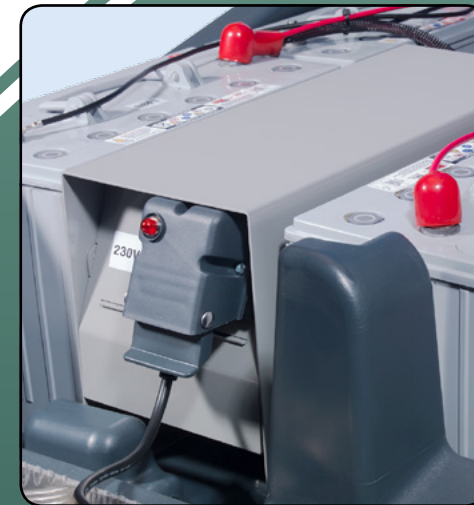

On-board charging

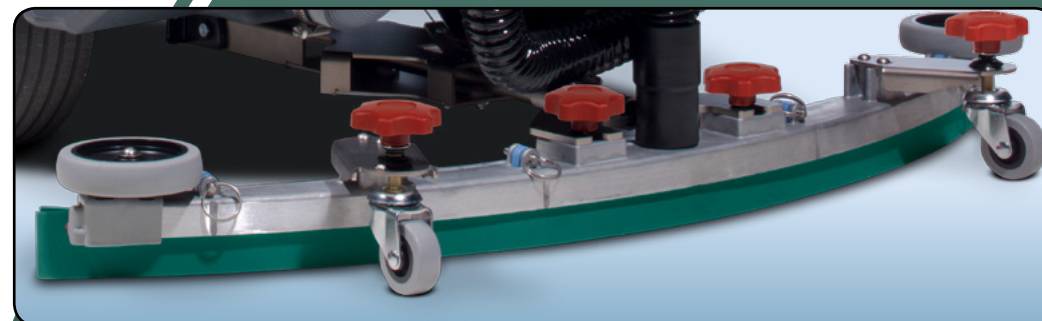

TRO Aluminium / Polyurethane floor tool

...A Serious Two Brush Workhorse

- Twin Brush**
 650 twin brush power head cleaning system.
- Easy Brush Access**
 Easy side access to brushes for maintenance.
- Controlled Cleaning**
 Fully adjustable water flow rate.
- On-board Charging**
 Easy and convenient, just plug and go. Fully sealed low maintenance Gel batteries.
- Simple Operator Control**
 Full dashboard control with soft touch Nutronic controls.
- Safety Features**
 Emergency stop button, power off removable key, horn button and hazard warning light and built in reversing alarm are just a few of the many safety features included.
- Easy Maintenance**
 Easy access to batteries and fuses for maintenance.



Full control dashboard

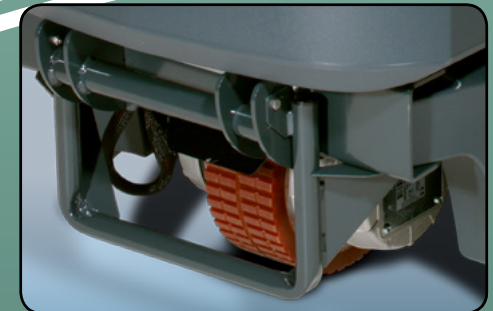

Drive wheel protector

A full 120 litre capacity with a fixed 650mm twin brush power head the TRO650G is ready to go.



Model	Brush Motor	Vac Motor	Power	Runtime	Recharge Time	Traction Drive	Drive Speed	Cleaning Speed
TRO650G	2 x 400W	600W	4 x 12V (24V) = 200Ah	3.5hr	8hr	600W	0-7.0km/h	3.5km/h
Scrub Width	Brush Speed	Water Capacity	Water Flow Rate	Climbing Gradient	Weight	Dimensions (WxLxH)		
650mm	200rpm	120L	3, 2, 1, 0.5L/min	11%	365kg	944x1676x1425mm		

TwinTec Vario *Three Into One Does Go*

A comfortable, driver friendly, 120 litre, front wheel drive machine with a fantastic turning radius, gets in and out of places other machines just won't go.

The TwinTec Vario "three in one" (3 in 1) design has proved itself to be almost the perfect balance between sound common sense engineering and innovative and truly functional technology.

Yes, one machine which can be set to 3 different working widths: 650, 750 and 850 and all at the flick of a simple selection lever. This doesn't even need tools – anybody can do it at any time. You want it wide – fine... you want it narrow – 30 seconds is all that it takes.

The Vario TTV678G, three brush widths in one system

The unique arrangement of 3 independent scrubbing heads which, by virtue of a simple adjustment mechanism, can provide a choice of scrubbing widths which, with the addition of a selection of brushes and pads, can provide customised performance on almost any surface application.



TTV678

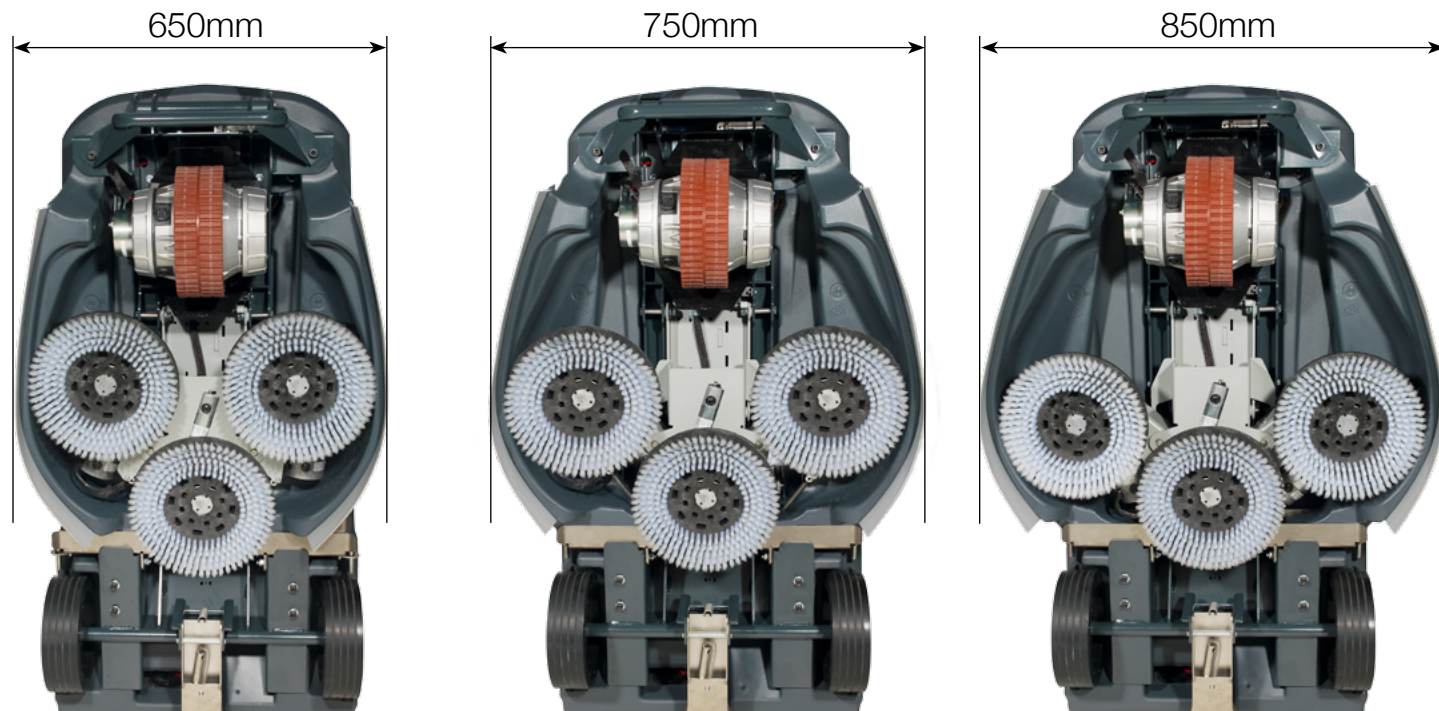

As unique today as when it started - patented technology

- Vario 3 in 1 Brush System**
 Simple adjustment mechanism provides a choice of scrubbing widths suitable for almost any surface.
- Easy Dosing Pre-sets**
 Correct chemical dosing for every task.
- Complete Cleaning Control**
 Operator has full control of cleaning speed, brush speed, water flow and chemical dosing.
- Simple Operator Control**
 Soft touch dashboard control system.
- Easy Maintenance**
 Easy access to batteries and fuses for service purposes and brush change is simple with the swing out brush cover.
- On-board Charger**
 Simple and convenient, just plug and go. Fully sealed low maintenance Gel batteries.
- Small Turning Radius**
 Means great cleaning even in tight spaces.
- Safety Features**
 Emergency stop button, power off removable key, horn button and hazard warning light and built in reversing alarm are just a few of the many safety features included.
- Easy Maintenance**
 Easy access to batteries and fuses for maintenance.



Control panel

Vario, the machine that gives you what you want.

In many applications changing circumstances change specific needs, so with the Vario you can change the specification to suit your exact requirements. It's not only the working widths that can be changed; it's the full operating performance that is under the driver's complete control – cleaning speed, brush speed, water flow and chemical dosing, nothing left to chance.



Hazard light

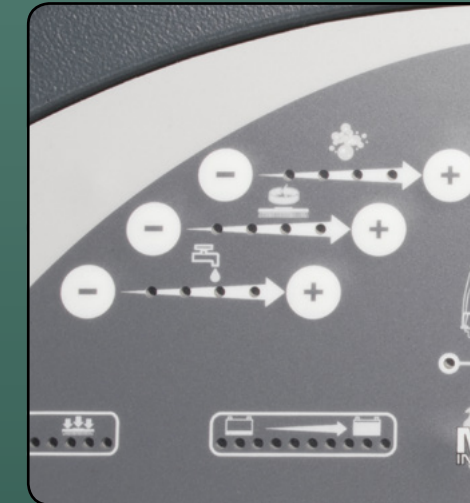

Dosing controls



Easy brush change

Model	Brush Motor	Vac Motor	Power	Runtime	Recharge Time	Traction Drive	Drive Speed	Cleaning Speed	Climbing Gradient
TTV678G	3x24V 400W	24V 600W	6 x 12V (24V) = 300Ah 8 x 12V (24V) = 400Ah (Optional)	3.5hr 4.5hr	8-12hr	600W	7.0km/h	3.5km/h	11%
Scrub Widths	Brush Speed	Water Capacity	Nuchem Capacity	Water Flow Rate	Nuchem Mix	Gross Weight (full)		Dimensions (WxLxH)	
650mm 750mm 850mm	50 / 100 / 150 / 200rpm	120L	Optional 5L	4L/min 3L/min 2L/min 1L/min	25:1 50:1 75:1 100:1	6x12V+620kg 8x12V+684kg		1054x1676x1425mm	

(See pages 30-31 for full accessories) 27

Accessories

Using genuine Numatic accessories will ensure you achieve the best results from your FloorCare machine.

Each accessory is developed with professional cleaners in mind, good quality design makes all the difference when a task is repeated day after day.

Hurricane and NuSpeed Accessories



HFT / HFM Solution Tank PN:606890



NR Solution Tank PN:606084



NLL Solution Tank PN:606101



NR 10kg Weight For NR 1500S PN:606113
HFM 10kg Weight For HFM 1500S PN:606077



HFM / NPR Dustrol Kit (Blue) PN:606178

HNS 1550 Dustrol Kit (Blue) PN:900834

NR Dustrol Kit (Grey) PN:606056

HFM / NR Dustrol Control Brush Ring (Also Standard With Dustrol Kits) PN:606079



NR Optional Spraytec Kit PN:606054

HFM / HNS Optional Spraytec Kit PN:606325

TwinTec / Vario Blade Sets



TT1840G / TTB1840G Replacement Blade Set (2 pieces) PN:903531

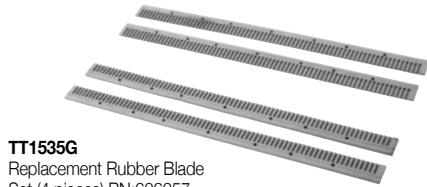

TT1535G Replacement Rubber Blade Set (4 pieces) PN:606057



TT1535G Optional Replacement Polyurethane Blade Set (4 pieces) PN:606091

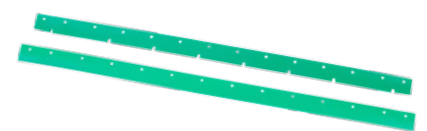

TGB3035 / TT4045G / TGB4045 / TT4055G / TGB4055 / TGB6055 / CRO8055G / CRO8072G / TTV678G / TRO650G Replacement Polyurethane Blade Set
TGB3045 / TT4045G / TGB4045 / CRO8055G / CRO8072G / TTV678G (805mm) PN:900518
TT4055G / TGB4055 / TGB6055 (944mm) PN:900519
TTV678G / TRO650G (1053mm) PN:900520

TwinTec / Vario Floor Tools



Plastic Floor Tool Polyurethane TT / TTB 1840G Blade PN:903532

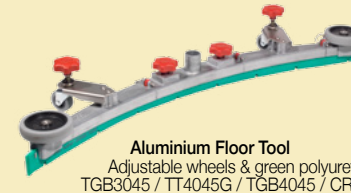

Aluminium Floor Tool Adjustable wheels & green polyurethane blades included
TGB3045 / TT4045G / TGB4045 / CRO8055G / CRO8072G / TTV678G (650) PN:904691
TT4055G / TGB4055 / TGB6055 (750) PN:904699
TTV678G / TRO650G (850) PN:904694

TwinTec / Vario Accessories



All TT / TGB Machines Wander Floor Kit (32mm) (Except TT / TTB1840G) PN:607250



All TGB / TRO / TTV Machines Wander Floor Kit (38mm), TGB PN:606193, TRO / TTV PN:606182 (Except TT / TTB1840G)



CRO Machines Wander Floor Kit (38mm), c/w fitting kit PN:903183



TTV678G 38mm Emptying Hose Extension PN:606186



TwinTec / Vario Emptying Hose Extension Kit PN:609100

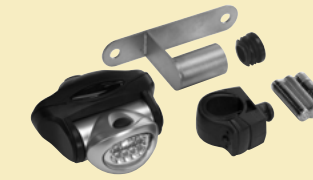

TTV678G Battery LED Front Light Kit PN:606170



TwinTec / Vario Aluminium Floor Tool Wide Angle Adjustable Castor Plate Upgrade Kit PN:606319

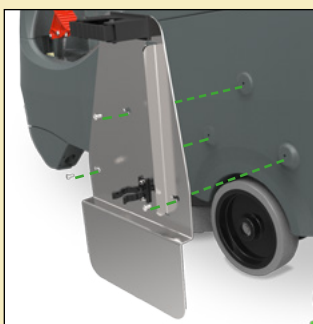

CRO Spray Mop Mounting Kit PN:903182



TRO / TTV / CRO Caddy Kit (Red) CRO PN:902505 (shown above) TRO / TTV PN:902739

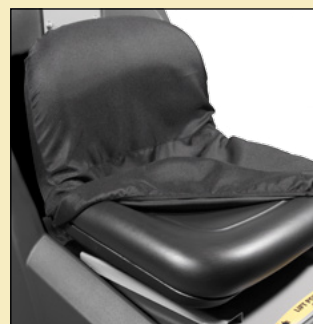

TRO / TTV Replacement Seat Cover PN:604053



Generic 20m Cable Roll Extension UK PN:612002 20m Cable Roll Extension EUR PN:612003



NuTab dosing tablets 90 x 20 Litre Bucket 9 x packs of 10 Tablets PN:903981



TTB1840G Battery & Charger Pack UK PN:606266 EUR PN:606267 CH PN:606268 USA PN:606269 SA PN:606270 AUS PN:606271



TTB1840G Charger Pack UK PN:606272 EUR PN:606273 CH PN:606274 USA PN:606275 SA PN:606276 AUS PN:606277 (Boxed) PN:606260



**Numatic International
Limited,**

Chard, Somerset,
TA20 2GB,
UNITED KINGDOM

Tel: 01460 68600
Fax: 01460 68458

www.numatic.co.uk



**Numatic International
S.A.S,**

13/17 rue du Valengelier,
EAE la Tuilerie,
77500 Chelles,
FRANCE

Tel: 01 64 72 61 61
Fax: 01 64 72 61 62

www.numatic.fr



**Numatic International
BV**

BeNeLux Distribution
Numatic International BV
Postbus 101
2400 AC Alphen aan den Rijn
NEDERLAND

Tel: 0172 467 999
Fax: 0172 467 970

www.numatic.nl



**Numatic International
GMBH**

Fränkische Straße 15-19,
30455 Hannover
DEUTSCHLAND

Tel: 05 11 98 42 16 0
Fax: 05 11 98 42 16 20

www.numatic.de



**Numatic International
Schweiz AG.**

Sihlbruggstraße 142
6340 Baar,
SCHWEIZ

Tel: 041 768 07 60
Fax: 041 768 07 69

www.numatic.ch



**Numatic International
ULDA**

Centro de Negócios da Maia
Rua Albino José Domingues
n.º 581 4470 - 034 Maia
PORTUGAL

Tel: 351 220 047 700

www.numatic.pt



**Numatic International
(Pty.) Ltd.**

16th & Pharmaceutical Roads,
Midrand, Gauteng, S.A. 1685.

Tel: 0861 686 284
Fax: 0861 686 329

www.numatic.co.za

