

Original Instructions



Warning! Read instructions before using the machine

Operating Instructions

WV 1500, WVD 1500, WV 2000, WVD 2000

WV 1500-AP, WVD 1500-AP, WV 2000-AP, WVD 2000-AP



Numatic
INTERNATIONAL

www.numatic.com



WVD-2000AP



WV 1500AP

WV 2000AP

WVD 1500AP

WVD 2000AP



WV 1500
WVD 1500

WV 2000
WVD 2000



BS7



WVD-2000



10mm



WVD-2000AP



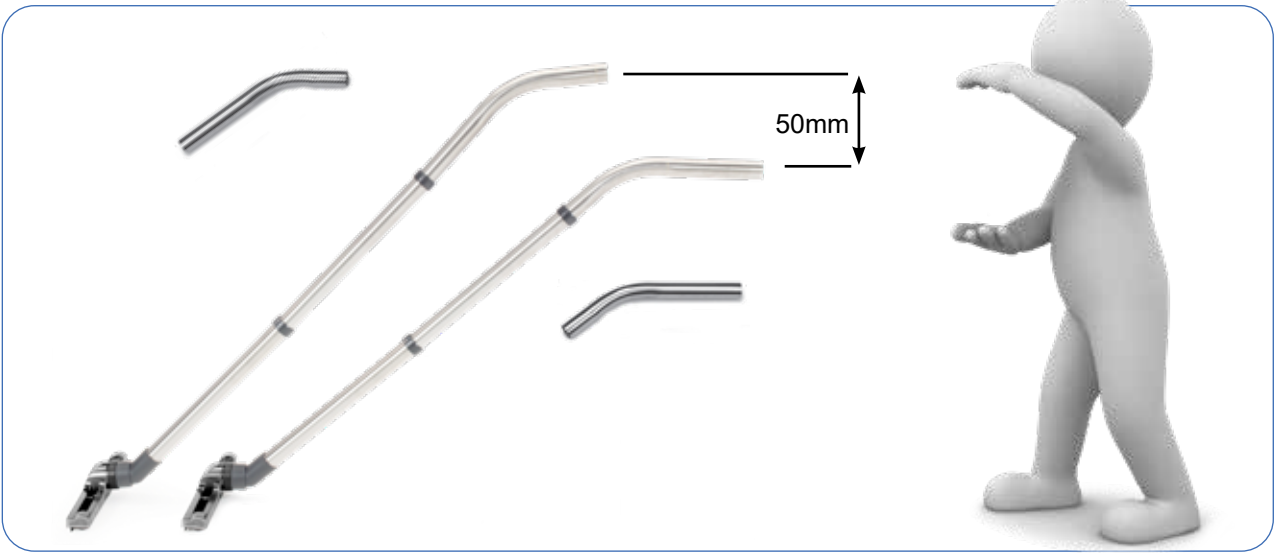

*WV 1500AP
WVD 1500AP
WV 2000AP
WVD 2000AP*



*WV 1500
WVD 1500
WV 2000
WVD 2000*



*WV 1500AP
WVD 1500AP
WV 2000AP
WVD 2000AP*





Assembling the machine



WV 1500, WVD 1500, WV 2000, WVD 2000



WV 1500AP, WVD 1500AP, WV 2000AP, WVD 2000AP



204245
10M Hose

1



2



3



5

4



6



7

8



7

About the machine

Company name and address

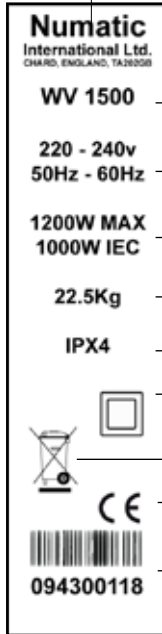

- Machine Description
- Voltage / Frequency
- Power Rating
- Weight (Ready to use)
- Splash Proof Rating
- Class 2 Symbol
- WEEE Logo
- CE Mark
- Yr / Wk / Serial Number

WEEE Legislation (Waste, Electrical and Electronic Equipment)

Vacuum cleaner, accessories and packaging should be sorted for environmental-friendly recycling.

Only for EU countries:
Do not dispose of Vacuum cleaner into household waste!
According to the European Directive 2002/96/EC on waste electrical and electronic equipment and its incorporation into national law.

Vacuum cleaners that are no longer suitable for use must be separately collected and sent for recovery in an environmental-friendly manner.



Safety Critical Components

Mains lead

HO5VV-F x 10m x 2 x 1.00mm²
HO5VV-F x 10m x 2 x 2.50mm²
HO5VV-F x 10m x 3 x 1.50mm²

Filter Bag

NVM-3 BH >pp< construction 99.6%@0.3µm
NVM-4 BH >pp< construction 99.6%@0.3µm

Filter

Prematex NVM 604116 >pp< construction 96.0%@0.3µm

PPE

Personal protective equipment that may be required for certain operations.



Ear Protection



Safety Footwear



Head Protection



Safety Gloves



Dust / Allergens Protection



Eye Protection



Protective Clothing



Hi Viz Jacket



Caution Floorsign

NOTE:

A risk assessment should be conducted to determine which PPE should be worn.

Data

WV / WVD 1500 WD / WVD 1500AP

	Motor	AirFlo	Suction	Cleaning Range	Class
WV 1500	1060 W	49 L/sec	2400 mm	26.8m	II
WVD 1500	1060 W x2	98 L/sec	2400 mm	26.8m	II
WV 1500AP	1060 W	49 L/sec	2400 mm	26.8m	I
WVD 1500AP	1060 W x2	98 L/sec	2400 mm	26.8m	I
	Capacity Dry	Capacity Wet	Size	Weight	Sound Pressure
WV 1500	70 Ltrs	50 Ltrs	640x530x970	22.5 Kgs	73.7dB (IEC 60704-2-1) Uncertainty: 0.2 dB (A)
WVD 1500	70 Ltrs	50 Ltrs		25.0 Kgs	
WV 1500AP	70 Ltrs	50 Ltrs		29.0 Kgs	
WVD 1500AP	70 Ltrs	50 Ltrs		31.0 Kgs	

WV / WVD 2000 WV / WVD 2000AP

	Motor	AirFlo	Suction	Cleaning Range	Class
WV 2000	1060 W	49 L/sec	2400 mm	26.8m	II
WVD 2000	1060 W x2	98 L/sec	2400 mm	26.8m	II
WV 2000AP	1060 W	49 L/sec	2400 mm	26.8m	I
WVD 2000AP	1060 W x2	98 L/sec	2400 mm	26.8m	I
	Capacity Dry	Capacity Wet	Size	Weight	Sound Pressure
WV 2000	90 Ltrs	70 Ltrs	640x530x970	24.1 Kgs	73.7dB (IEC 60704-2-1) Uncertainty: 0.2 dB (A)
WVD 2000	90 Ltrs	70 Ltrs		28.9 Kgs	
WV 2000AP	90 Ltrs	70 Ltrs		30.4 Kgs	
WVD 2000AP	90 Ltrs	70 Ltrs		36.4 Kgs	

Information for Wet & Dry Use Vacuum Cleaners

WARNING

Read the instruction manual before using the machine.

Operators shall be adequately instructed on the use of these machines.

As with all electrical equipment, care and attention must be exercised at all times during use, in addition to ensuring that routine and preventative maintenance is carried out periodically to ensure safe operation.

Failure to carry out maintenance as necessary, including the replacement of parts to the correct standard could render this equipment unsafe and the manufacturer can accept no responsibility in this respect.

The machine shall be disconnected from the mains by removing the plug from the supply socket during cleaning or maintenance and when replacing parts or converting the machine to another function.

The machine is not to be used by children or persons with reduced physical, sensory or mental capabilities, or lack of experience or knowledge, unless they have been given supervision or instruction.

Children being supervised are NOT to play with the machine.

This appliance is intended to be assembled, cleaned and maintained by an adult.

This machine is not a toy.

Only use the socket outlet on the machine for purposes specified in the instructions.

CAUTION!

If foam/liquid comes out of machine exhaust, switch off immediately. Allow the accumulated liquid to drain out through the machine exhaust, check the float assembly to ensure correct operation, empty the container if full of liquid, reassemble the machine. Immediately upon start up there will be a certain amount of liquid issuing from the machine exhaust which will be the residue of liquid still within the power head. This will be quickly discharged after which the machine should function normally.

Liquid ejected from the machine could be hazardous as a result of its temperature, pressure or chemical content.

This machine is not suitable for the collection of biological hazards, hazardous or explosive dust. You should contact your local distributor if you require a machine capable of performing these tasks.

Ensure that the filtration system fitted to the machine is suitable for the material being collected.

This machine is for indoor use only.

This machine shall be stored indoors only

This product complies with the requirements IEC 60335 -2.69.

When moving from one place to another, consider the weight of the machine.

NOTE: This machine is also suitable for commercial use, for example in hotels, schools, hospitals, factories, shops and offices for other than normal housekeeping purposes.

DO

- Use a bag and filter at all times when using 'dry'.
- Keep your machine clean.
- Keep filters clean.
- Regularly clean the water level limiting float safety valve and examine for signs of damage or correct operation.
- Keep hoses and tubes clear.
- Replace any worn or damaged parts immediately.
- Regularly examine the power cord, if damage is found, power cord must be replaced by a qualified person using the correct Numatic original part.
- Empty dust container frequently.
- Keep diffuser filter (where fitted) clean.

DON'T

- Use steam cleaners or pressure washers to clean the machine or use the machine in the rain.
- Immerse in water for cleaning.
- Allow any inexperienced repairs. Call the experts.
- Use wet if float valve is not functioning or fitted.
- Use to suck up hot ashes, or lighted cigarette ends.
- Suck up liquid before emptying dirt from container.
- Suck up dirt before emptying liquid from container.
- Run the machine over the power cable during operation as a hazard may occur.
- Pull on the cable to unplug the machine from the power supply.
- Walk over-wet carpets, upholstery or fabrics.
- Walk on clean carpets until fully dry.
- Spray onto people or animals.
- Attempt machine maintenance or cleaning unless the power supply plug has been removed from the supply outlet.

This machine can be used for wet and dry pick up.

Dry Mode maintenance / fault finding

If the vacuum cleaner stops working switch off and remove the plug from the wall before investigating were the fault lies.

If the vacuum cleaner will not pick up any debris from the surface, switch off and remove the plug from the wall, inspect the floor tool, wands and hose for blockages, if no blockages are found, the dust bag may be full if the dust bag is not full the filter may be blocked.

Wet mode / fault finding

If the vacuum cleaner stops working switch off and remove the plug from the wall before investigating were the fault lies.

If the vacuum cleaner has a blockage and will not pick up liquid, switch off and remove the plug from the wall, has the float valve operated, this will shut off the suction and the pitch of the vacuum motor will change Remove the power head and empty the liquid out of the container, if the container is empty, check that the floor tool wands and hose are not blocked.

After use always inspect the machine for damage.



EU DECLARATION OF CONFORMITY

We hereby declare under our sole responsibility that the following equipment fulfils all the relevant provisions of the following EU Directives:

- Machinery Directive 2006/42/EC
- EMC Directive 2014/30/EU
- RoHS Directive 2011/65/EU

Machine Description: Vacuum Cleaner
Type: WVD, WV, CV, CVD series

Manufactured by: Numatic International Limited

Relevant standards upon which conformity is declared include:

- IEC 60335-1 2001 + A1 2004 + A2 2006 + National Deviations
- IEC 60335- 2-2 2002 + A1 +A2
- IEC 60335-2.69 2002 + A2
- EN 55014-1 2001 +A1 2001, +A2 2002
- EN 55014-2 1997 + A1 2001 (Cat II)
- EN 50366 2003 + A1 2006

A technical construction file for this equipment is retained at the manufacturer's address under the authorisation of the following signatory:

Name: Allyn Boyes **Position:** Technical Manager

Signed:

Date: 20/04/2016



Numatic International Limited,
 Chard, Somerset.
 TA20 2GB
 www.numatic.co.uk

GB

14" Duplex PTO 240V
WD-0246 (A06)

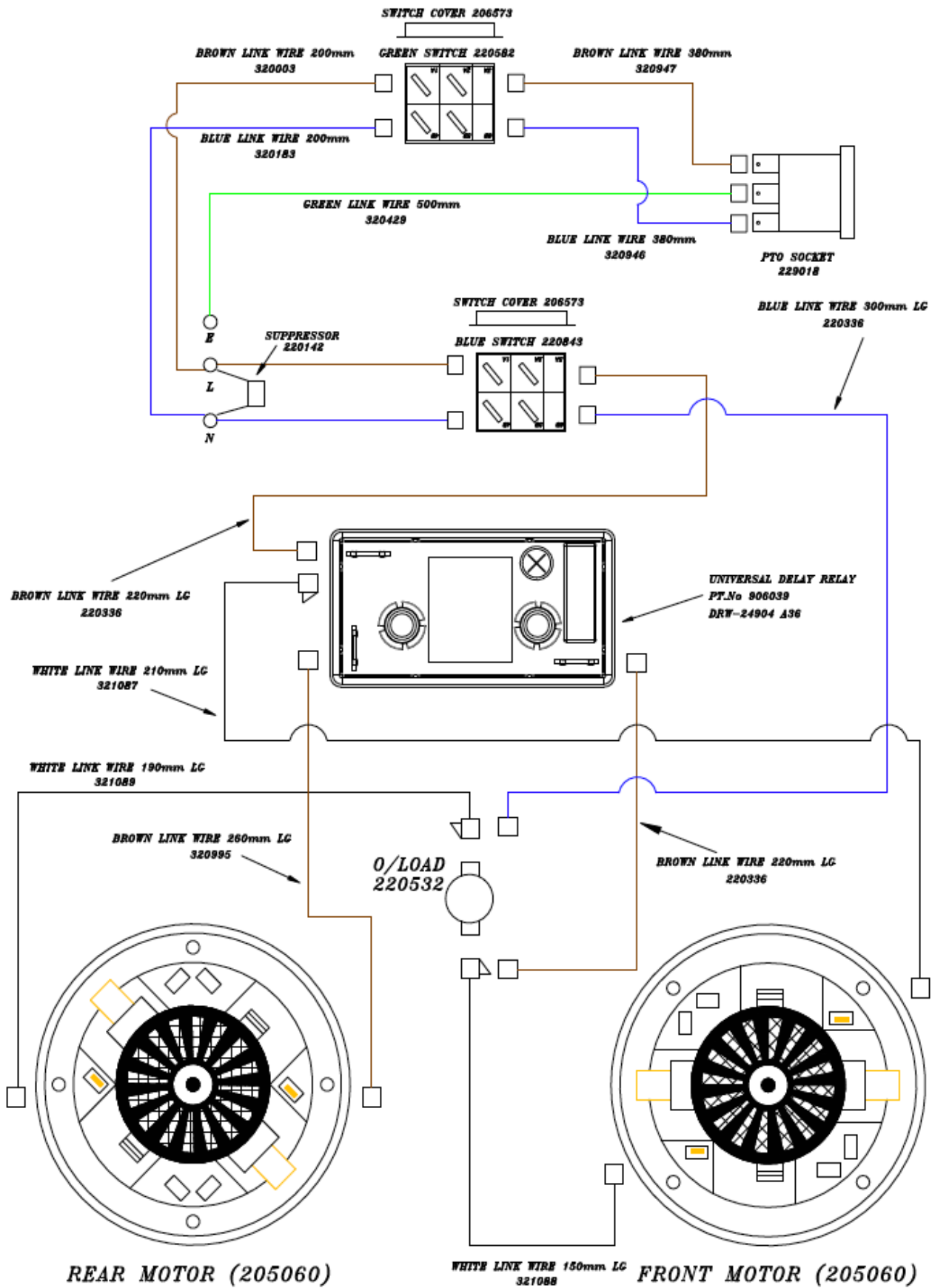

Wiring Diagram

14" Simplex AP/PH 240V / 120V
WD-0244 (A03)

Wiring Diagram

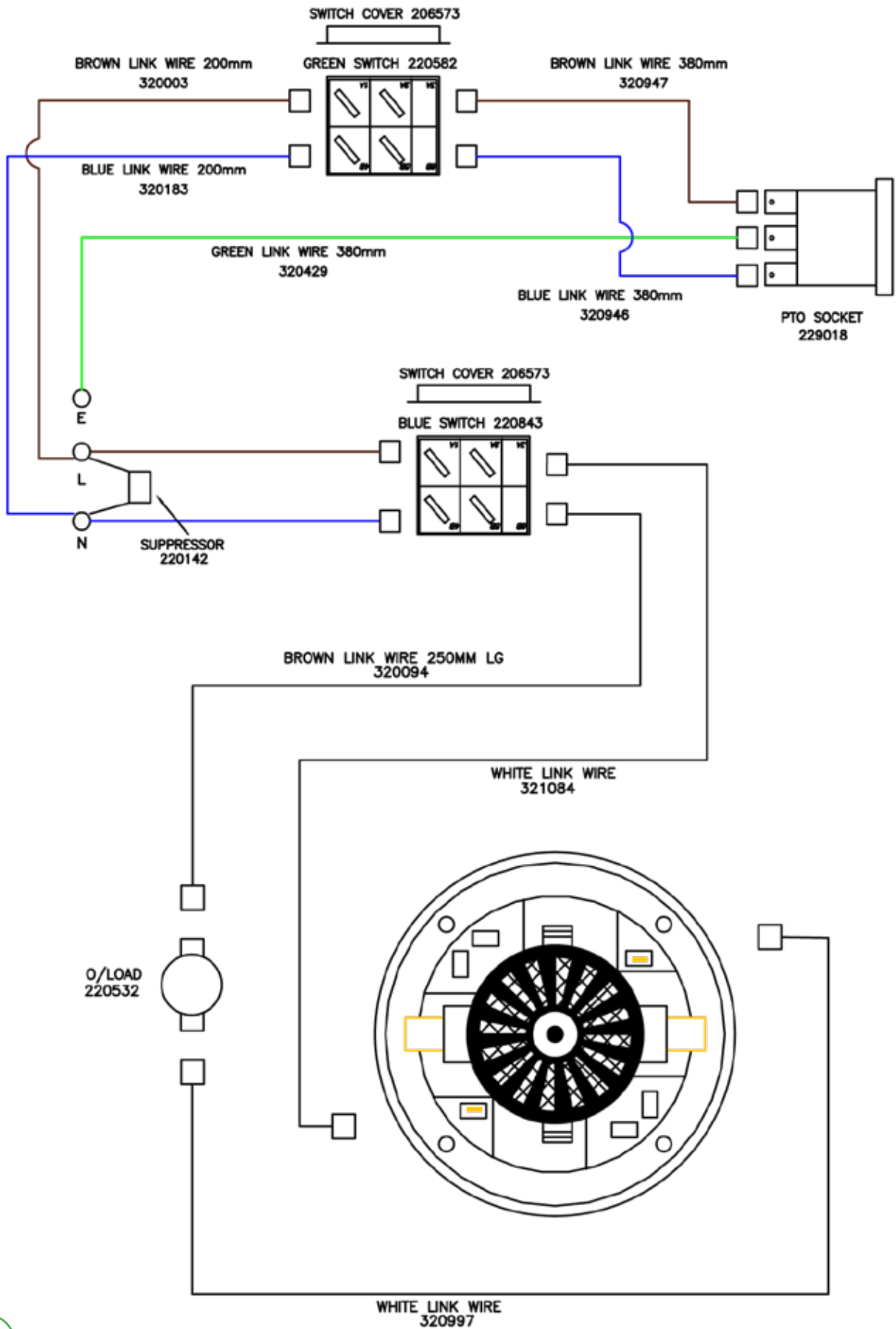

14" WV Simplex 240V / 120V
WD-0245 (A05)

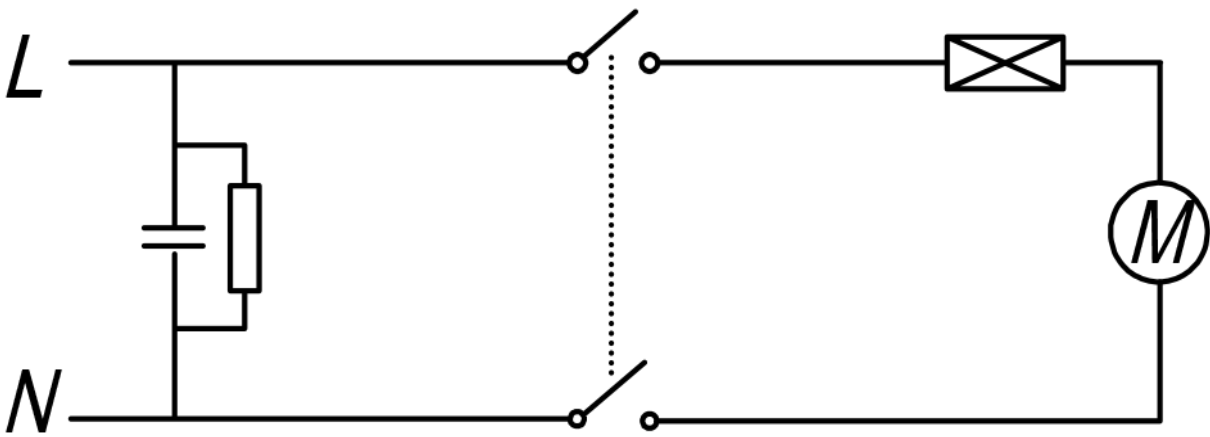

14" WVD Duplex 230V
WD-0255 (A06)

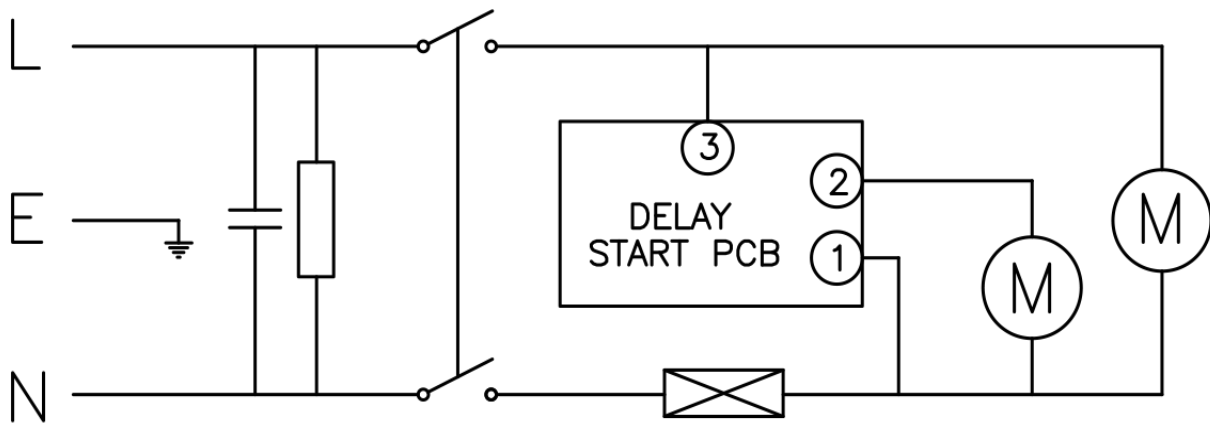

14" WV Simplex 220V
WD-0289 (A01)

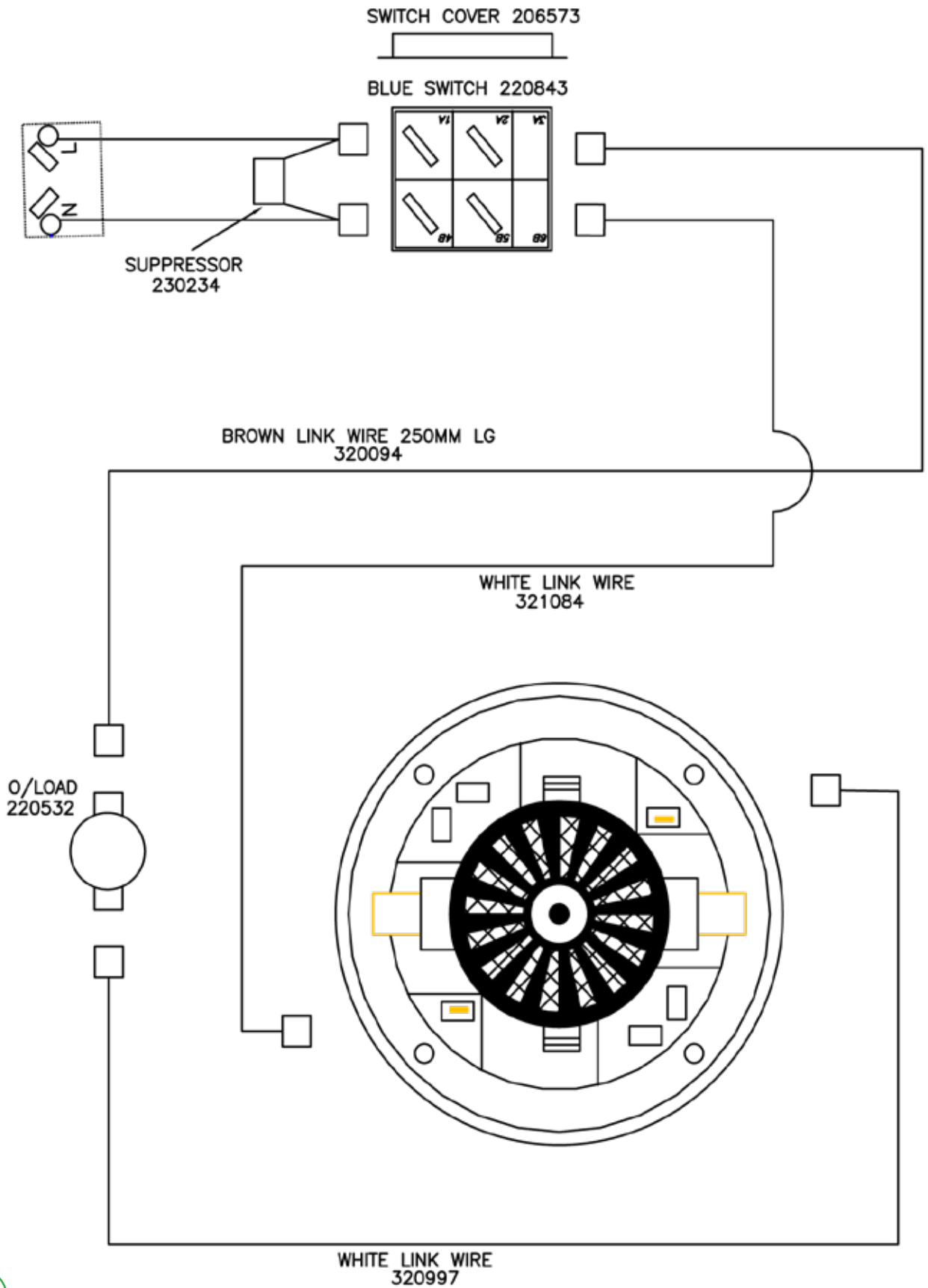

14" WV Simlex AP/PH 220V
17/03/05 WD-0288 (A01)

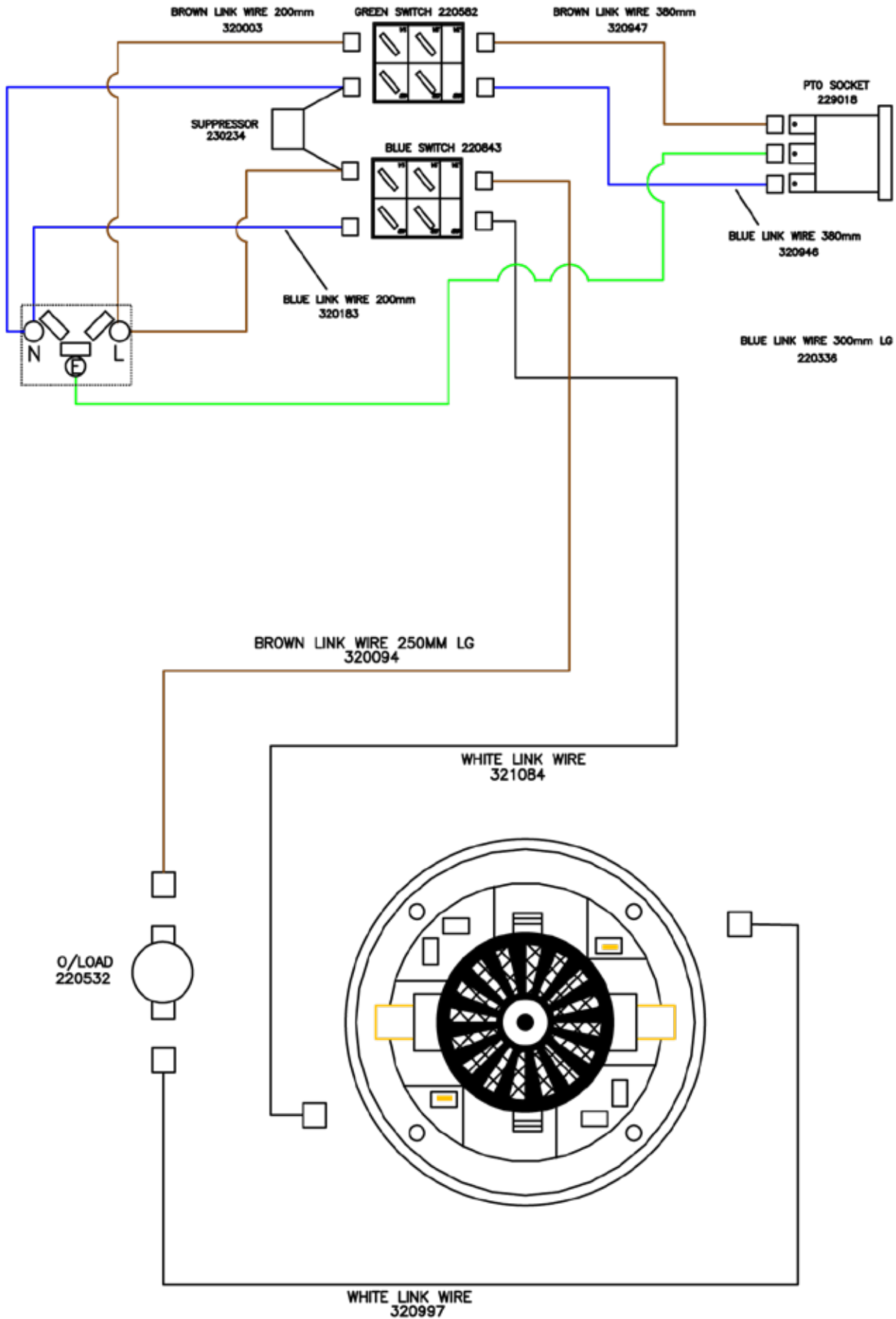

14" WV Duplex AP/PH 220V
WD-0290 04/03/09 (A03)

Wiring Diagram

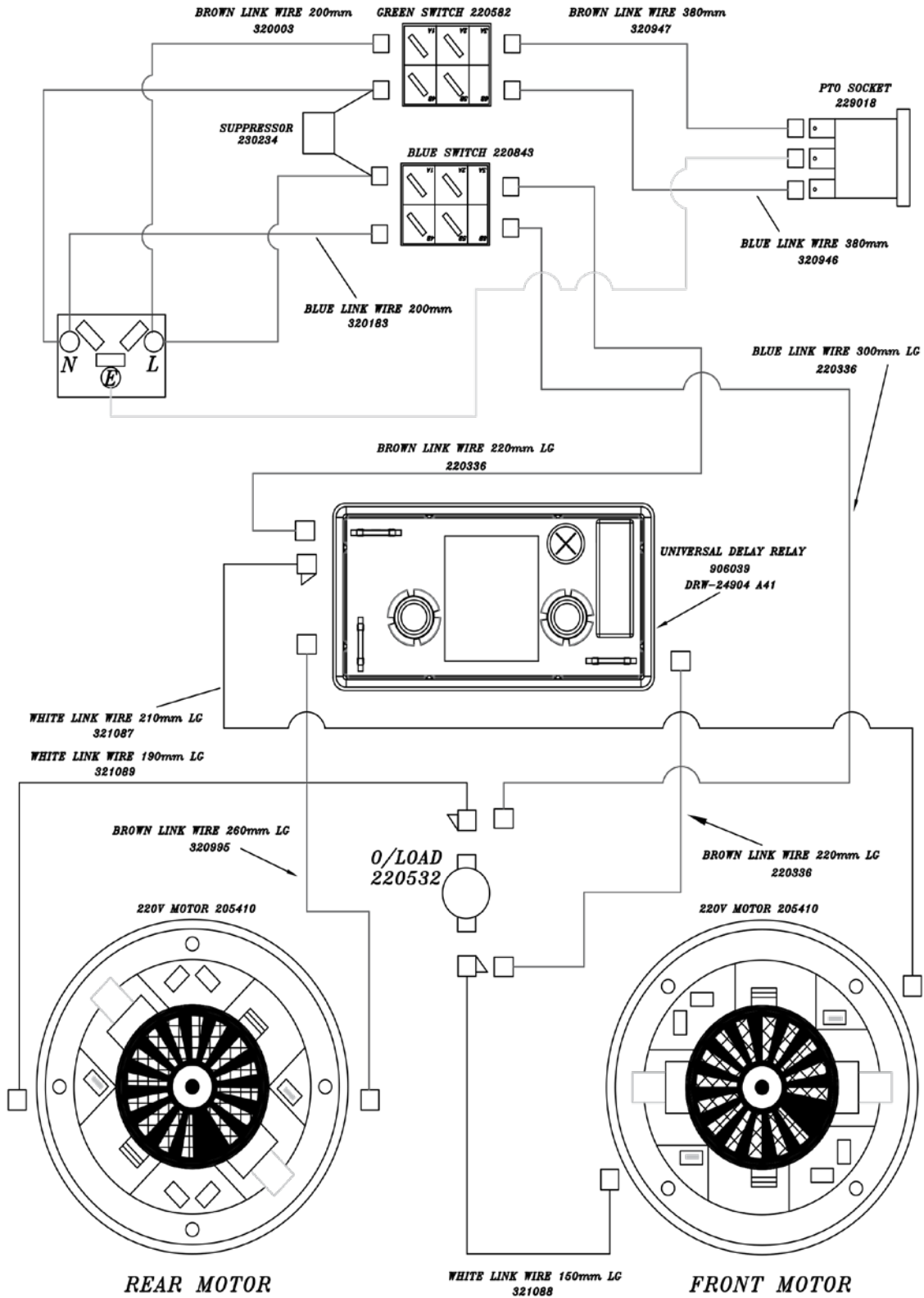

14" WV Duplex 220V
WD-0293 05/03/09 (A03)

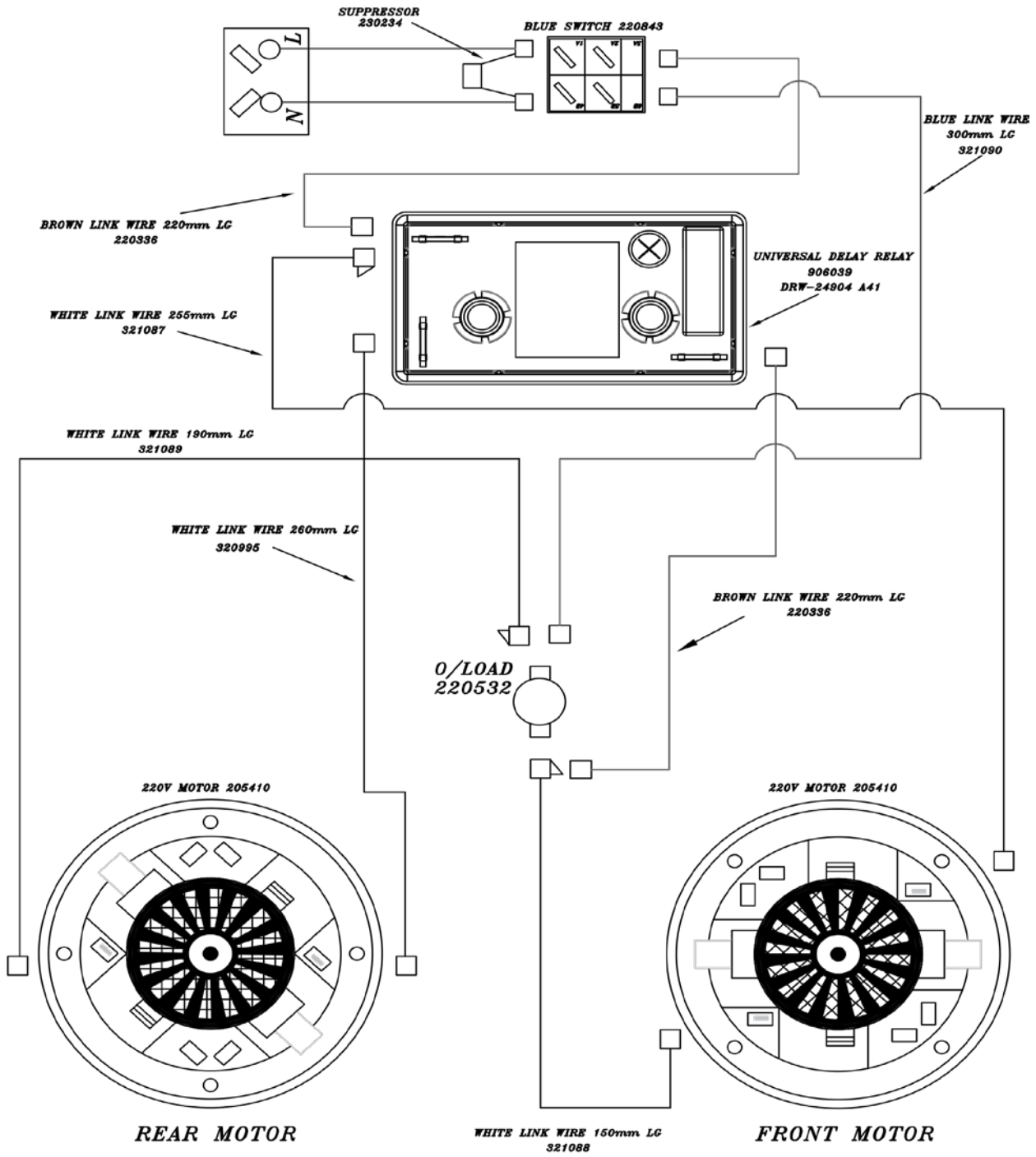

Wiring Diagram

Wiring Diagram

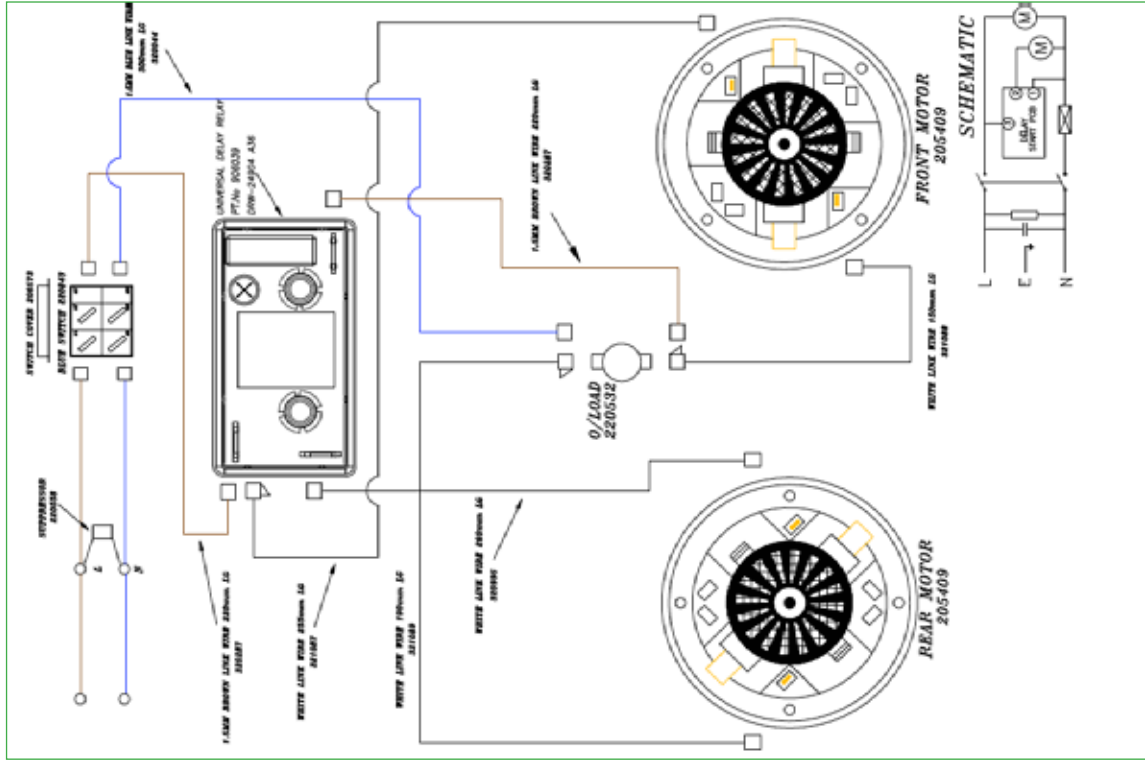

14" WV Duplex 120V
WD-0257 (A03)

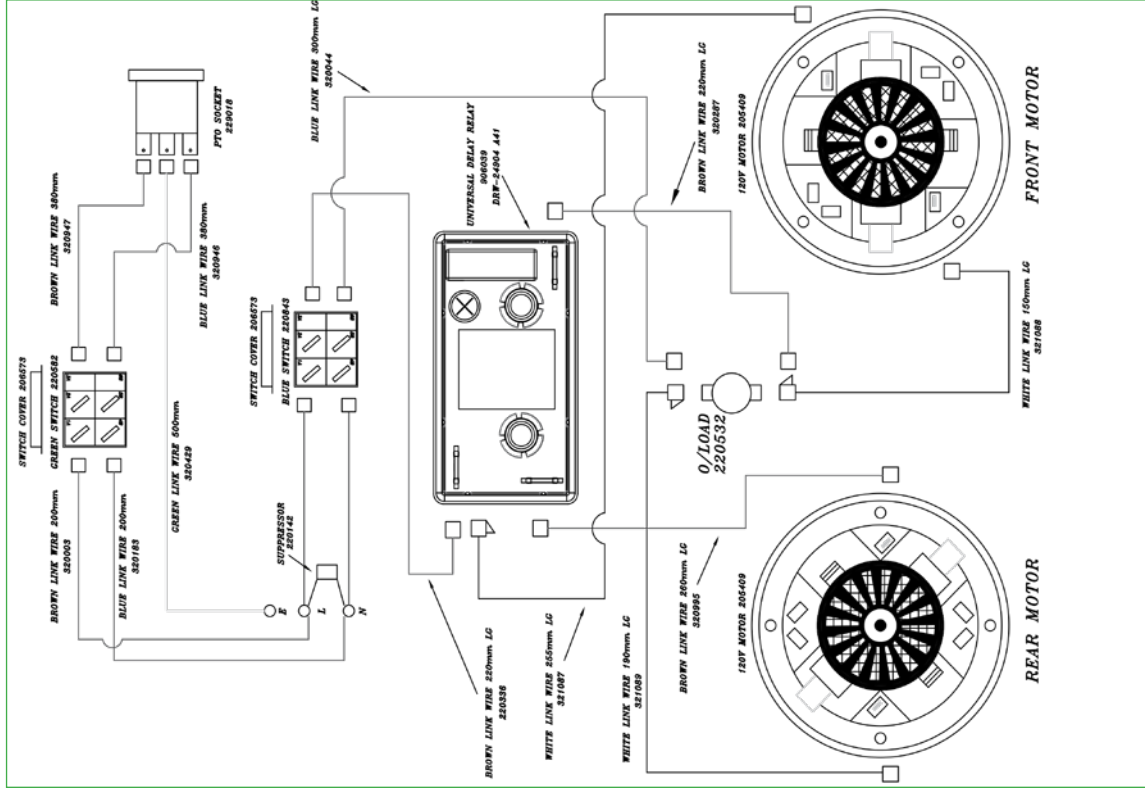

14" WV Duplex PTO120V
WD-0259 (A03)

Numatic International Warranty

Numatic International Limited warrant to the original purchaser that its products are free of defects in both material or workmanship for the period shown below:-

Homecare and Cleancare Vacuum cleaners.....	2 Years
Rotary Floor Machines.....	2 Years
Twintec Auto Scrubber Dryer.....	1 Year
Vario Ride-On Scrubber Dryer.....	1 Year / 1500 hours
Mopping, Compacts, Combi and Servocare Products.....	1 Year
Individual Accessories and Spare Parts.....	6 Months

Note: This warranty expressly excludes consumable parts such as carbon brushes, floor brushes, mops, batteries etc, that are considered replaceable from time to time during the normal working life of the machine.

Using non Numatic dustbags can be detrimental to both machine performance and life and may invalidate the Warranty.

- A. The warranty period commences from the date the goods are purchased.*
- B. All warranty claims must be processed through the Dealer from whom the equipment was purchased. The Dealer will co-operate with the purchaser throughout the warranty claims procedure and will arrange any necessary repairs using genuine Numatic parts.*
- C. If the original Dealer is no longer able to fulfil his obligations please contact Numatic International Limited with full details of the claim and proof of purchase so that this may be processed without delay.*
- D. Any warranty claim can only relate to the specific part that is proven to be at fault and for which a replacement will be supplied but cannot be extended to constitute a claim against the complete machine.*
- E. Numatic International will supply the Dealer with any warranty parts required, subject to the claim being validated, after return of the faulty items in accordance with Numatic International Limited's General Conditions of Sale.*
- F. Claims will not be accepted if they are the result of fair wear and tear, misuse or abuse of any kind.*
- G. No replacement will be given unless the appropriate evidence of the validity of the claim has been provided to the satisfaction of Numatic International Limited.*
- H. Numatic International Limited reserve the right to charge for any unnecessary work carried out as a result of an invalid claim.*
- I. No variation to this warranty may be made or implied by any member of Numatic International Limited or its Dealers unless such variation is in writing and authorised by the Company*



Numatic International Limited. Chard, Somerset, TA20 2GB

Telephone: 01460 68600 Fax: 01460 68458

© Numatic International Limited

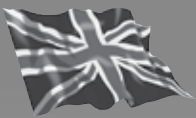

Numatic International Limited.
Chard, Somerset TA20 2GB ENGLAND
Tel: 01460 68600 www.numatic.co.uk

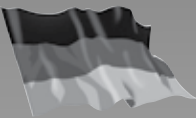

Numatic International GmbH. Fränkische Straße 15–19
D-30455 Hannover, DEUTSCHLAND
Tel: 05 11 98 42 16 0 www.numatic.de



Numatic International SAS. 13 / 17 rue du Valengelier
77500 CHELLES, FRANCE
Tel: 01 64 72 61 61 www.numatic.fr



BeNeLux Distribution, Numatic International BV
Postbus 101, 2400 AC Alphen aan den Rijn, NEDERLAND
Tel: 0172 467 999 www.numatic.nl

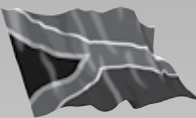

Numatic International (Pty.) Ltd.
16th & Pharmaceutical Roads, Midrand, Gauteng,
SOUTH AFRICA 1685
Tel: 0861 686 284 www.numatic.co.za



Numatic International Schweiz AG.
Sihlbruggstrasse 3A, 6340 Baar. SCHWEIZ
Tel: 0041 (0) 41 76 80 76 - 0 www.numatic.ch

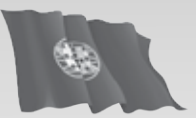

Numatic International ULDA. Centro de Negócios da Maia,
Rua Albino José Domingues, 581, 4470 – 034 Maia PORTUGAL
Tel: +351 220 047 700 www.numatic.pt



Numatic International SLU. C/ La Forja, 41, 08840 Viladecans
(Barcelona), Spain
Tel: +34 93 647 22 22 www.numatic.es

Specification subject to change without prior notice
www.numatic.co.uk © Numatic International Limited